

31 OKT. 1996

Dolby Prologic AV Receiver FR732/00

Service
Service
Service

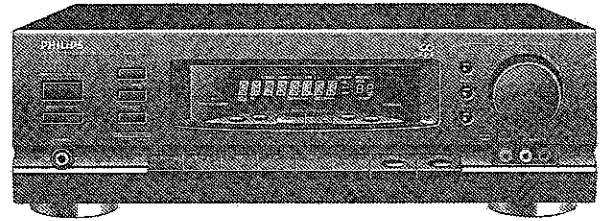

Service Manual

CONTENT	PAGE
Safety	1
Controls - Front	2
- Remote Control	3
Installation	4
Block Diagram	5
Wiring Diagram	6
Specifications	6
Radio Alignment	7
Tuning Board - Circuit Diagram	7
- Layout Diagram	8
Front Board - Circuit Diagram	9
- Layout Diagram	10
Main Board - Circuit Diagram	11
- Layout Diagram	12
Power Supply Board - Circuit Board	13
- Layout Board	14
Service Test Program	15 - 16
Exploded View Diagram	17
Electrical Partslist	18 - 20



HANDLING CHIP COMPONENTS

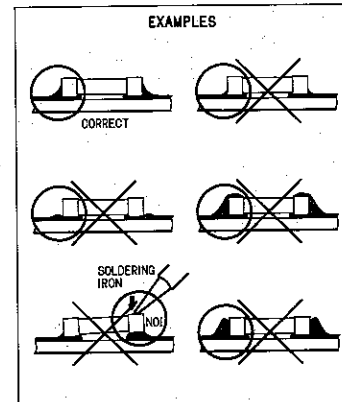
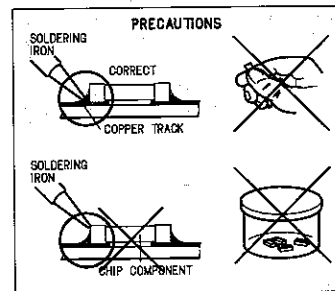
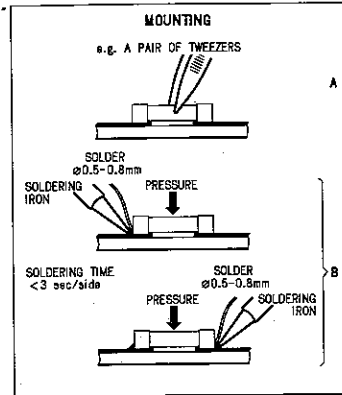
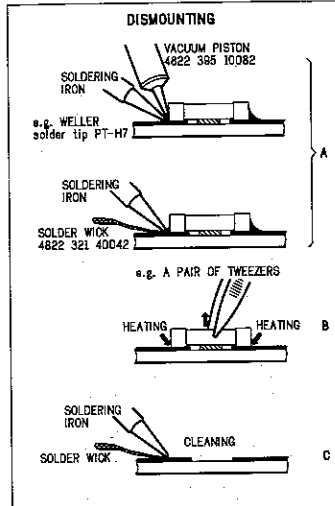
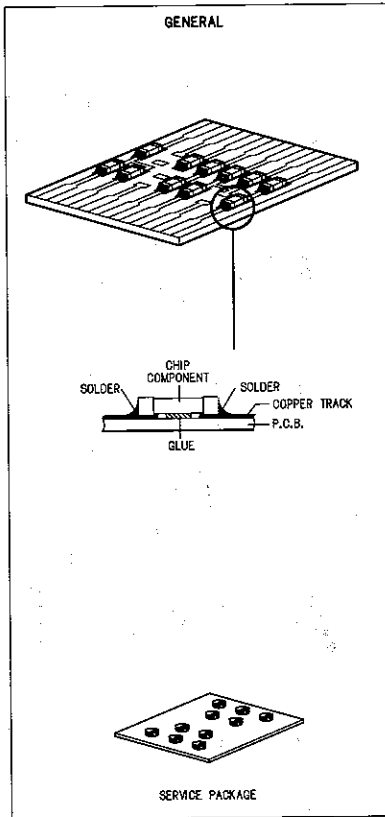

GB WARNING

All ICs and many other semiconductors are susceptible to electrostatic discharges (ESD). Careless handling during repair can reduce life drastically. When repairing, make sure that you are connected with the same potential as the mass of the set via a wrist wrap with resistance. Keep components and tools at this potential.

F ATTENTION

Tous les IC et beaucoup d'autres semi-conducteurs sont sensibles aux décharges statiques (ESD). Leur longévité pourrait être considérablement écourtée par le fait qu'aucune précaution n'est prise à leur manipulation. Lors de réparations, s'assurer de bien être relié au même potentiel que la masse de l'appareil et enfilez le braceleterti d'une résistance de sécurité. Veillez à ce que les composants ainsi que les outils que l'on utilise soient également à ce potentiel.



D WARNUNG

Alle ICs und viele andere Halbleiter sind empfindlich gegenüber elektrostatischen Entladungen (ESD). Unvorsichtige Behandlung im Reparaturfall kann die Lebensdauer drastisch reduzieren. Sorgen Sie dafür, daß sie im Reparaturfall über ein Pulsarmband mit Widerstand mit dem Massepotential des Gerätes verbunden sind. Halten Sie Bauteile und Hilfsmittel ebenfalls auf diesem Potential

NL WAARSCHUWING

Alle IC's en vele andere halfgeleiders zijn gevoelig voor electrostatische ontladingen (ESD). Onzorgvuldig behandelen tijdens reparatie kan de levensduur drastisch doen verminderen. Zorg ervoor dat u tijdens reparatie via een polsband met weerstand verbonden bent met hetzelfde potentiaal als de massa van het apparaat. Houd componenten en hulpmiddelen ook op ditzelfde potentiaal.

I AVVERTIMENTO

Tutti IC e parecchi semi-conduttori sono sensibili alle scariche statiche (ESD). La loro longevità potrebbe essere fortemente ridotta in caso di non osservazione della più grande cauzione alla loro manipolazione. Durante le riparazioni occorre quindi essere collegato allo stesso potenziale che quello della massa dell'apparecchio tramite un braccialetto a resistenza. Assicurarsi che i componenti e anche gli utensili con quali si lavora siano anche a questo potenziale.

Anti-static table mat large 1200x650x1.25mm
small 600x650x1.25mm

Anti-static wrist band
Connection box (1M0hm)
Extendible cable (to connect wrist band to conn. box)
Connecting cable (to connect table mat to conn. box)
Earth cable (to connect any product to mat or box)
Complete kit ESD3 (combining all above products)
Wristband tester

4822 466 10953
4822 466 10958
4822 395 10223
4822 320 11307
4822 320 11305
4822 320 11306
4822 320 11308
4822 310 10671
4822 344 13999

GB

Safety regulations require that the set be restored to its original condition and that parts which are identical with those specified be used. Safety components are marked by those symbol. ▲

S Varning!

Osynlig laserstrålning när apparaten är öppnad och spårer är urkopplad. Betrakta ej strålen.

DK Advarsel!

Usynlig laserstrålning ved åbning når sikkerhedsafbrydere er ude af funktion. Undgå udsættelse for stråling.

SE Varoitus!

Avalussa laiteessa ja suojalukituksen ohitettaessa olet alttiina näkyvämmälle laserisäteilylle. Älä katso säteeseen!

GB WARNING

Safety regulations require that the set be restored to its original condition and that parts which are identical with those specified be used.

F ATTENTION

Les normes de sécurité exigent que l'appareil soit remis à l'état d'origine et que soient utilisées les pièces de rechange identiques à celles spécifiées.

D WARNUNG

Bei jeder Reparatur sind die geltenden Sicherheitsvorschriften zu beachten. Der Originalzustand des Gerätes darf nicht verändert werden. Für Reparaturen sind Original-ersatzteile zu verwenden.

NL WAARSCHUWING

Veiligheidsbepalingen vereisen, dat het apparaat in zijn oorspronkelijke toestand wordt teruggebracht en dat onderdelen, identiek aan de gespecificeerde, worden toegepast.

I AVVERTIMENTO

Le norme di sicurezza estigono che l'apparecchio venga rimesso nelle condizioni originali e che siano utilizzati i pezzi di ricambio identici a quelli specificati.

CONTROLS - FRONT

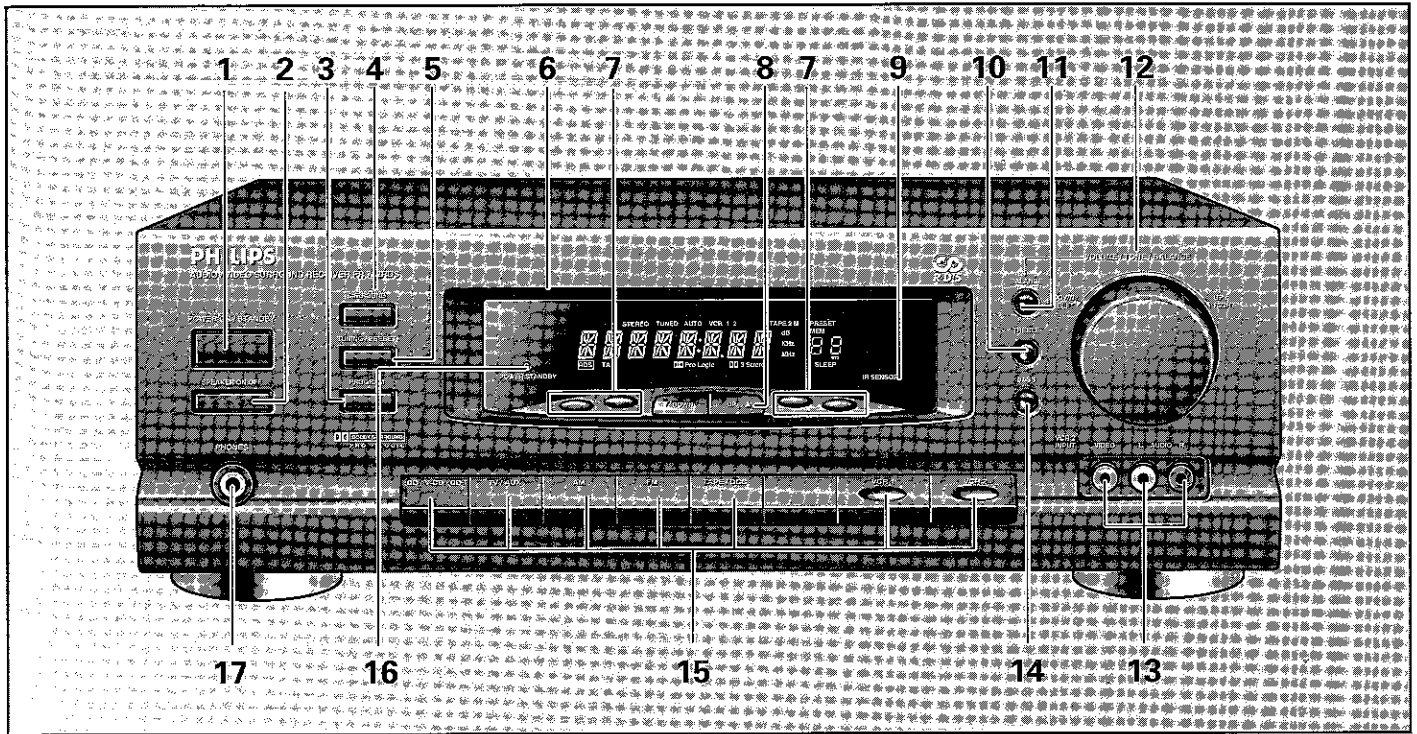

FRONT

1 POWER ON/STANDBY

For switching on to last mode and for switching off.

2 SPEAKERS ON/OFF

For switching the speakers connected to the FRONT SPEAKERS terminals on and off.

3 PROGRAM

For storing preset stations.

4 SURROUND

For selecting the surround modes:

DOLBY PRO LOGIC, DOLBY 3 STEREO, OFF.

Dolby Surround manufactured under license from Dolby Laboratories Licensing Corporation. 'Dolby' and the double D symbol  are trademarks of Dolby Laboratories Licensing Corporation.

5 TUNING/PRESET

For selecting the frequency or channel mode.

6 DISPLAY

Informs you about the functioning of the receiver.

7 RDS MODE CONTROLS (for FM only)

DISPLAY button: For changing the display mode

RDS button: To turn the RDS mode ON or OFF

AF button: To tune automatically to the frequency with the strongest signal for optimum reception of a RDS station

PTY button: To select the RDS station broadcasting the desired programme type (PTY)

8 UP/DOWN

- For adjusting the station frequency.
- For selecting the next or previous tuner preset.

9 I(nfra) R(ed) SENSOR

Infrared remote control eye for receiving signals from the remote control.

10 TREBLE

For adjusting the high tones (use together with the VOLUME/TONE/BALANCE control 12).

11 BALANCE

For adjusting the balance of the volume between the left and right channels (use together with the VOLUME/TONE/BALANCE control 12).

12 VOLUME/TONE/BALANCE

- **VOLUME** - For adjusting the volume.
- **TONE** - For adjusting the high tones and the bass tones (use together with the TREBLE 10 and BASS 14 controls).
- **BALANCE** - For adjusting the balance of the volume between the left and right channels (use together with BALANCE button 11).

13 VCR 2 AUDIO/VIDEO INPUT

Connections for an extra VCR or camcorder (VIDEO) or an extra audio source (AUDIO).

14 BASS

For adjusting the bass tones (use together with the VOLUME/TONE/BALANCE control 12).

15 SOURCE SELECTION KEYS

For selecting the required audio or video source.

16 POWER STANDBY LED

- Lights up when in stand by mode
- Flashes when MUTE is active

17 PHONES

For connecting headphones.

CONTROLS - REMOTE CONTROL

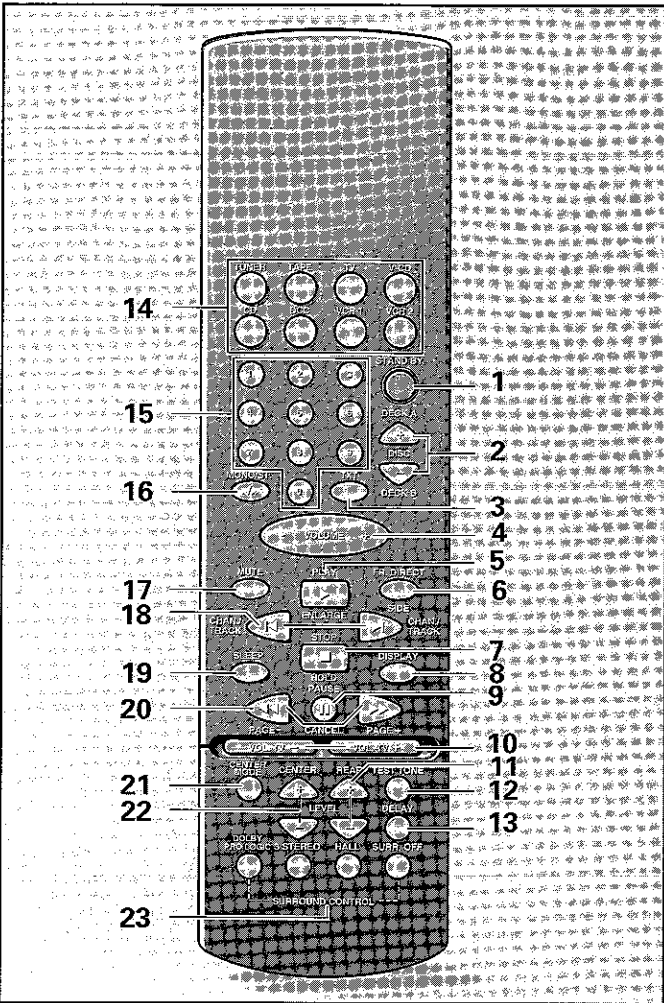

- 15 0-9 digit keys** – for selecting preset stations and frequency direct mode
- 16 MONO/ST** – for mono/stereo selection
- 18 CHANNEL/TRACK** – next ► or previous ◄ preset station
- 20 ◀◀ ▶▶** – for tuning up and down

TAPE

- 1 STANDBY** – for switching to standby
- 2 DECK A/DECK B** – for selecting deck A or B
- 5 PLAY ►** – for starting play
- 6 SIDE** – for selecting tape side A or B
- 7 STOP ■** – for stopping recording/play
- 9 PAUSE II** – for interrupting recording/play
- 18 CHANNEL/TRACK** – next ► or previous ◄ track
- 20 ◀◀ ▶▶** – for winding the tape

VCR 1 and VCR 2

- 1 STANDBY** – for switching to standby
- 5 PLAY ►** – for starting play
- 7 STOP ■** – for stopping recording/play
- 9 PAUSE II** – for interrupting recording/play
- 15 0-9 digit keys** – for selecting stations
- 18 CHANNEL/TRACK** – next ► or previous ◄ station
- 20 ◀◀ ▶▶** – for winding the tape

C D and V-CD/CD-i

- 1 STANDBY** – for switching to standby
- 2 DISC + -** (CD changer only) – for disc selection
- 5 PLAY ►** – for starting play
- 7 STOP ■** – for stopping recording/play/clearing a programme
- 8 DISPLAY** – for displaying the elapsed playing time and the remaining playing time during playback of a (V-) CD.
- 9 PAUSE II** – for interrupting recording/play
- 15 0-9 digit keys** – for track selection
- 18 CHANNEL/TRACK** – next ► or previous ◄ track
- 20 ◀◀ ▶▶** – for searching up and down

TV

- 1 STANDBY** – for switching to standby
- 3 TXT** – for switching teletext on and off
- 5 PLAY ►** – enlarge picture
- 7 STOP ■** – hold picture
- 8 DISPLAY** – for selecting on screen display
- 9 CANCEL** – cancel teletext
- 10 VOLUME TV** – for adjusting the volume
- 15 0-9 digit keys** – for selecting preset stations
- 16 -/ - -** 1 or 2 digit entry
- 18 CHANNEL/TRACK** – next ► or previous ◄ channel
- 20 PAGE + /PAGE - -** next or previous teletext page

DCC

- 1 STANDBY** – for switching to standby
- 2 DECK A/DECK B** – for selecting deck A or B
- 5 PLAY ►** – for starting play
- 6 SIDE** – for selecting the tape travel direction
- 7 STOP ■** – for stopping recording/play
- 8 DISPLAY** – for displaying character information (e.g. title names etc.)
- 9 PAUSE II** – for interrupting recording/play
- 15 0-9 digit keys** – for track selection
- 18 CHANNEL/TRACK** – next ► or previous ◄ track
- 20 ◀◀ ▶▶** – for winding the tape

AMPLIFIER

- 1 STANDBY** – for switching to standby.
- 4 VOLUME+VOLUME-** – for adjusting the volume
- 14 Source selectors**
- 17 MUTE** – for muting the volume.
- 19 SLEEP** – for setting a time period after which the system will automatically be switched to standby
- Surround processor**
- 11 REAR LEVEL +/-** – for adjusting the rear level (only in Dolby Pro Logic mode)
- 12 TEST TONE** – for checking the output level of the front, centre and rear speakers
- 13 DELAY** – for adjusting the delay time of the rear channel (has no influence on the FR 732 for the delay time is fixed).
- 21 CENTER MODE** – for selecting the desired centre mode when in Dolby Pro Logic or Dolby 3 Stereo mode
- 22 CENTER LEVEL +/-** – for adjusting the centre level (only in normal mode or wide mode)
- 23 SURROUND CONTROL**
- **PRO LOGIC, 3 STEREO** – for selecting the different surround modes (the HALL button has no influence on the FR 732).
- **SURR(ound) OFF** – for switching the surround mode off

TUNER

- 1 STANDBY** – for switching to standby
- 6 FR(equency) DIRECT** – for direct tuning to the station frequency
- 8 DISPLAY:**
- Indicates the frequency, the signal level, the Programme Service name, the Program Type and the clock time in RDS mode.
- indicates the frequency, the signal level in FM non-RDS mode

INSTALLATION

You only have to install your system once.
Please make the following connections (whenever applicable).

NOTES!

- **SWITCH OFF THE RECEIVER BEFORE MAKING ANY CONNECTIONS.**
- Do not connect the set to the mains when making connections.
- Be sure to connect the white plugs to the L (left) and the red plugs to the R (right) sockets when making connections.

Important note for connecting equipment that does not have PLAY/REC markings on the input and output sockets:

FR732	Device to be connected e.g. cassette deck.
PLAY →	PLAY or OUT
REC →	REC or IN

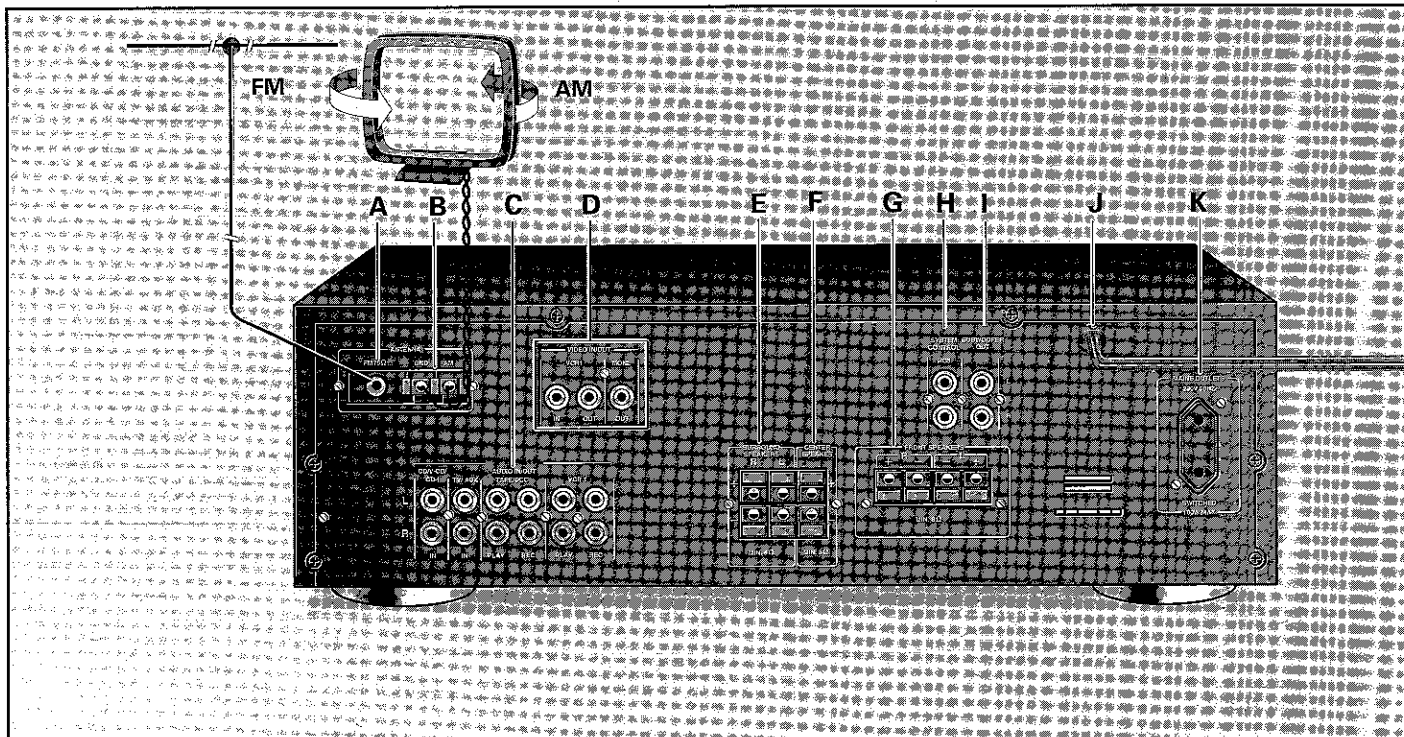

CONNECTIONS

A FM (75 Ω)

The FM (75 Ω) socket is used for connection to the Community or Cable Antenna System or to a roof-mounted FM antenna with an impedance of 75 ohms. If none of these are available, you may use the wire supplied for nearby stations (reception could be poor).

B GND/AM

For AM reception, connect the supplied wires to the GND and AM antenna terminals (one wire to GND and one wire to the AM terminal) and position the antenna for best reception.

Note: Do *not* place the AM loop antenna on the unit, as this unit employs a computing device which could cause interference.

C AUDIO IN/OUT

- **CD/V-CD/CD-i IN** – input sockets for connecting a CD (Compact Disc) player or a V-CD/CD-i player.
 - Connect these sockets to the OUTPUT sockets of the (V) CD player.
- **TV/AUX IN** – input sockets for connecting the sound channel of a TV set or any other source you want to hear; an additional CD player, a cassette deck, a VCR or a turntable with ceramic cartridge etc.
- **TAPE/DCC PLAY/REC** – input and output sockets for connecting a cassette deck.
 - Connect the PLAY sockets to the LINE OUTPUT sockets of the cassette deck.

- Connect the REC sockets to the LINE INPUT sockets of the cassette deck.
- **VCR 1 PLAY/REC** – input sockets for connecting the sound channel of a video recorder and output sockets for extra sound recording equipment (e.g. a HiFi stereo video recorder, or cassette, or tape deck).
 - Connect the PLAY sockets to the OUTPUT sockets of the VCR.
 - Connect the REC sockets to the INPUT sockets of the VCR

D VIDEO IN/OUT

- **VCR 1 IN/OUT** – input and output sockets for connecting the video input and output of a video recorder
- **MONI/OUT** – output sockets for connecting to the video input of a video TV set.

E SURROUND SPEAKERS

Terminals for connecting a pair of surround speakers, impedance of 8 Ω each, to obtain a surround sound effect
NOTE: Always connect *two* speakers to these terminals.

F CENTRE SPEAKER

Terminals for connecting a centre speaker.

G FRONT SPEAKERS A/B

Terminals for connecting two pairs of speakers, impedance 6-16 ohms (L = left, R = right).

- One of the wires of the loudspeaker cables is marked with a colour or rib. Connect the marked wire to the red terminal, the non-marked wire to the black one.

H SYSTEM CONTROL

RC-5 (coloured orange) – remote-control input/output socket for connection to the corresponding RC-5 socket of a CD (Compact Disc) player or a remote control receiver etc... Connect the RC-5 socket to the RC-5 socket of the external equipment that uses the RC-5 remote control system. This socket has been added to maintain compatibility with other Philips Audio equipment.

POWER

I SUBWOOFER OUT

For use with an externally powered subwoofer (not supplied). For details, please refer to the subwoofer's owners manual.

J MAINS LEAD

For connecting the set to the mains.

K MAINS OUTLETS

Switched mains output for connecting mains plugs from various units such as cassette deck, CD player, etc. (maximum capacity is 100 W).

Power supplied through this outlet is turned on and off by the POWER button of the receiver and STANDBY button on the remote control.

CONNECTING HEADPHONES

- Connect headphones with a 6,3 mm plug to the PHONES socket.
- Inserting the plug will not disconnect the loudspeakers.

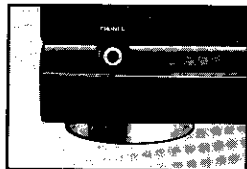

SPEAKER POSITIONING

To get the best surround sound effect in your home, place the speakers as shown below.

The left and right speakers should be about 1 m. (40") from the TV set.

The centre speaker should be above or below the TV set.

The rear speakers should be placed at normal listening ear level.

Note: to avoid interference with the TV picture, use only magnetically shielded speaker systems.

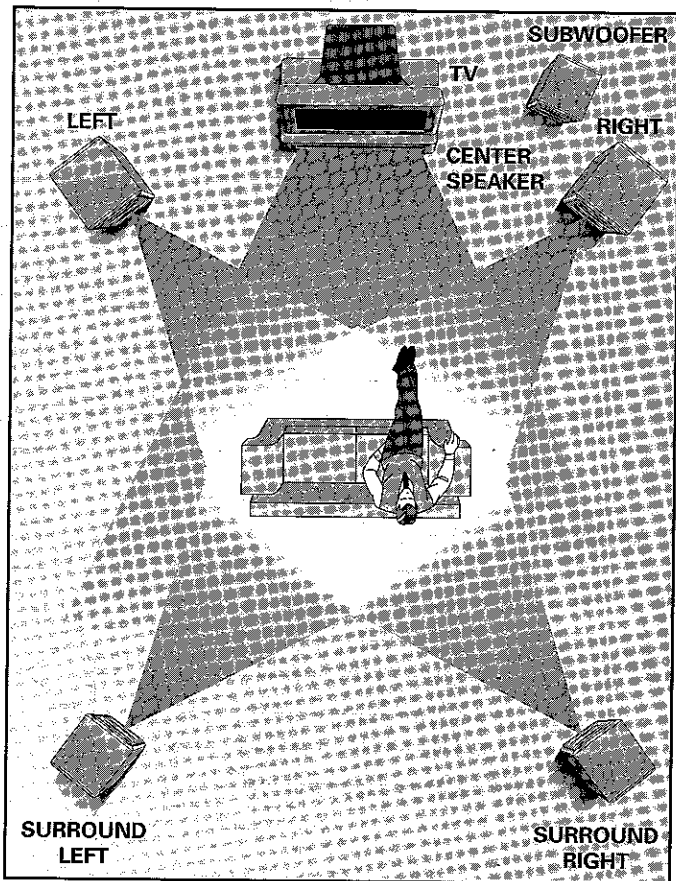

After making all necessary connections (some may not be applicable for your system set-up), your system is ready for use. In the next chapter we will describe how to operate your FR 732 receiver.

BLOCK DIAGRAM

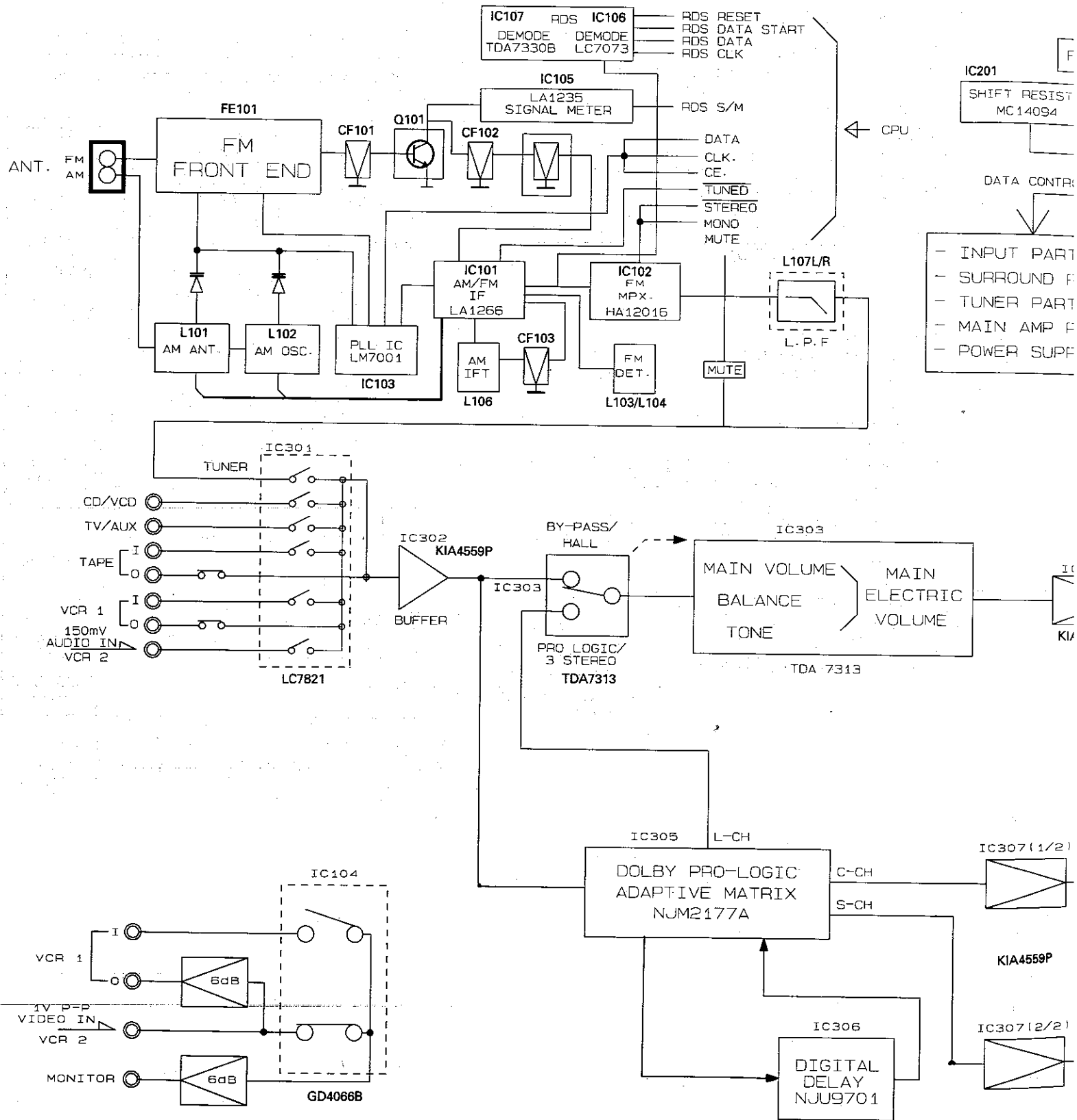

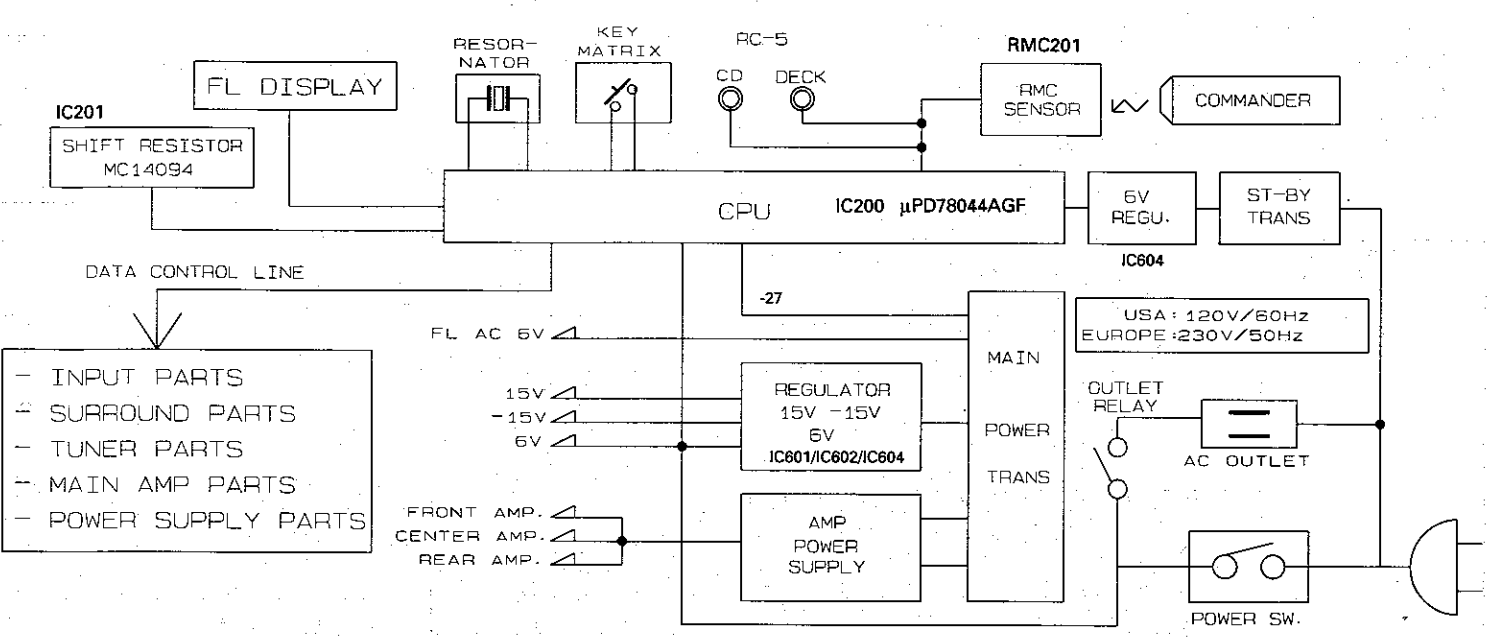

- INPUT PARTS
- SURROUND PARTS
- TUNER PARTS
- MAIN AMP PARTS
- POWER SUPPLY PARTS

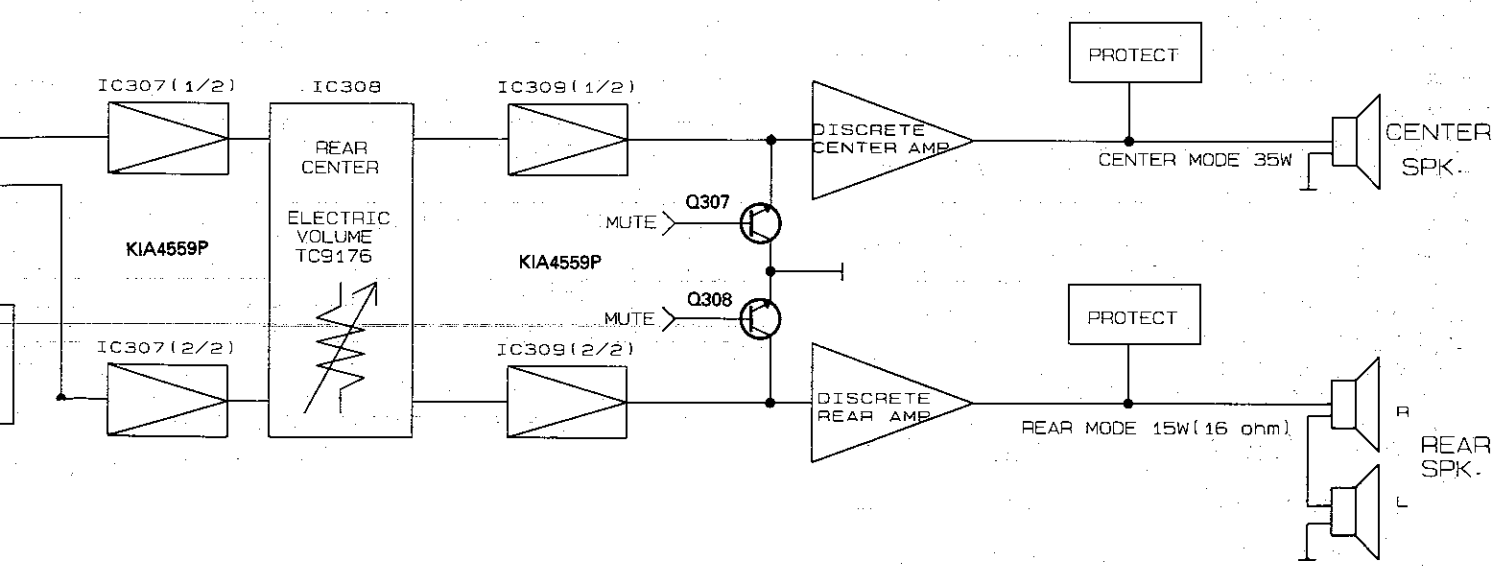
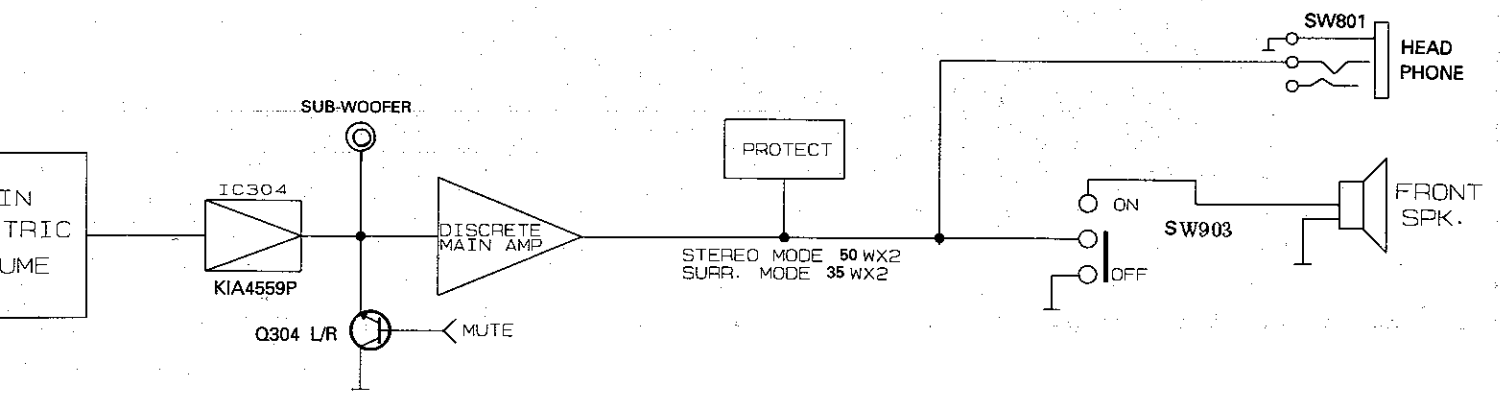

WIRING DIAGRAM

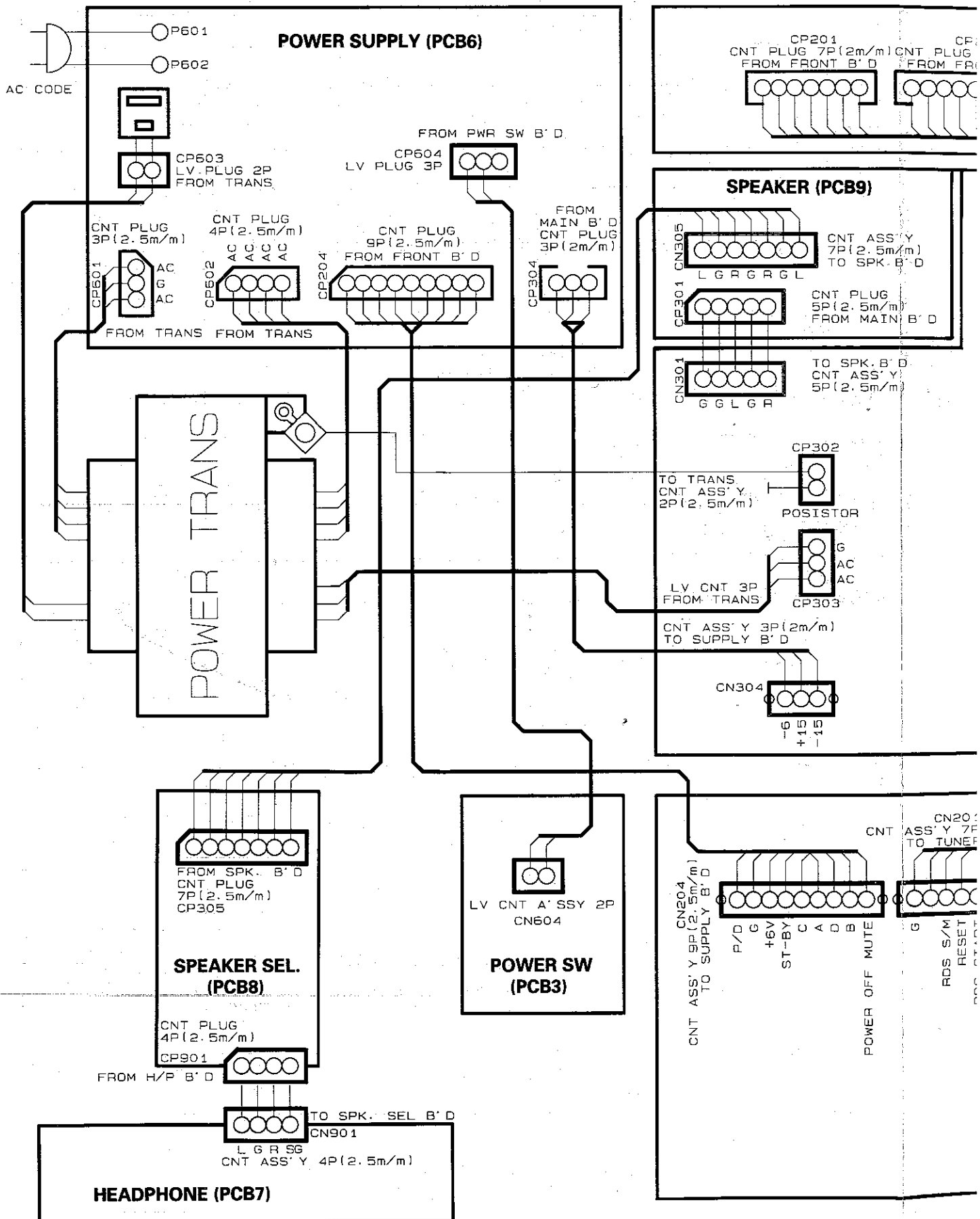

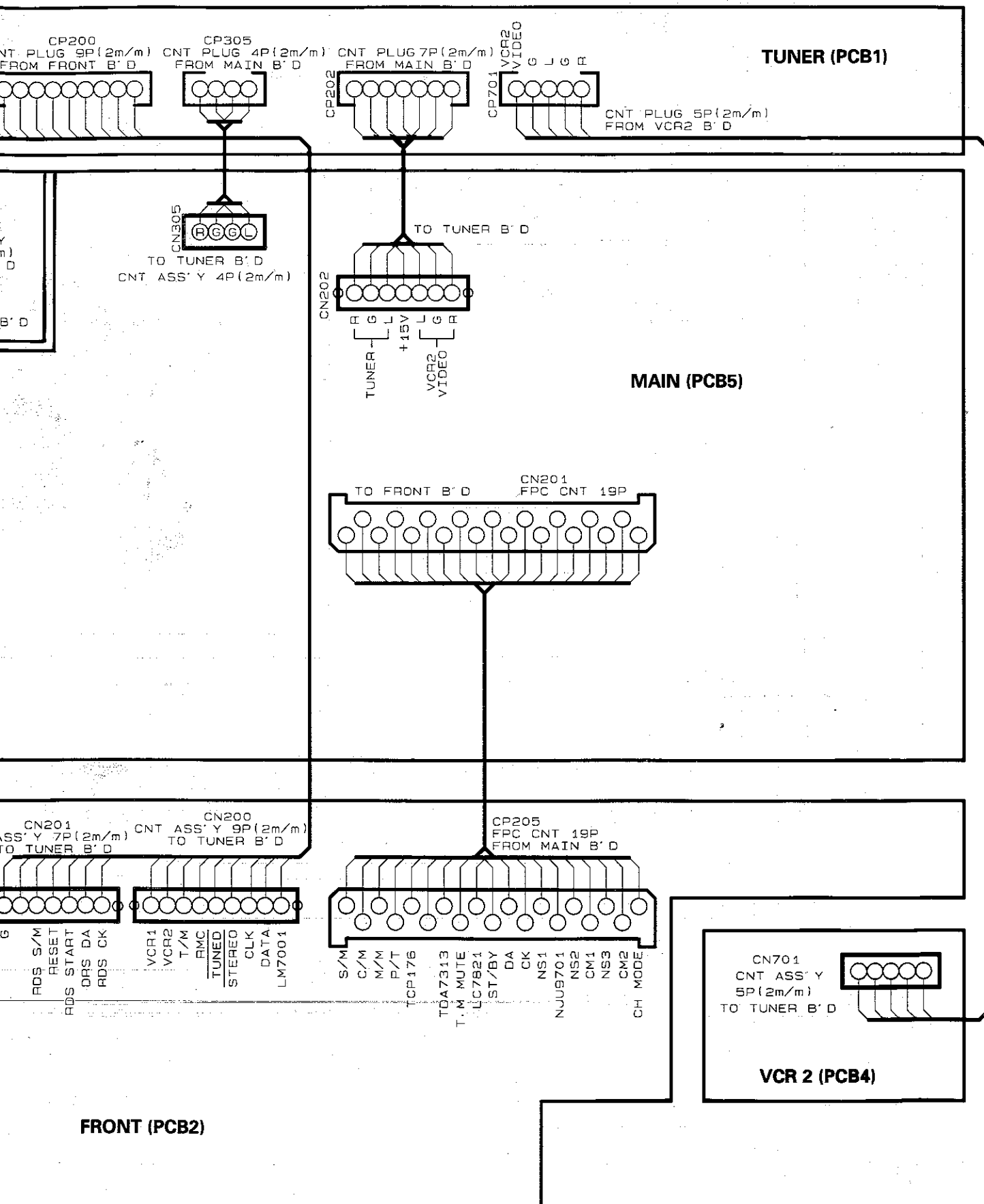

SPECIFICATIONS

GENERAL

Main voltage	:	230V
Main frequency	:	50Hz
Battery (remote control)	:	3V (R03G x 6)
Power Consumption	:	110W
Dimension (W x H x D)	:	435 x 125 x 350 mm
Weight	:	8.6 kg

AMPLIFIER

RMS Output power	Main	:	2 x 50 W
	Center	:	35 W
	Rear	:	2 x 15W
Speaker impedance	Main	:	2 x 8 Ohm
	Center	:	8 Ohm
	Rear	:	2 x 16 Ohm
Frequency response	Main	:	20 Hz - 40 KHz
	Center (PRO-LOGIC)	:	50 Hz - 15 KHz
	Rear (PRO-LOGIC)	:	100 HZ - 6 KHz
Tone control	Bass at 100Hz	:	12 dB
	Treble at 10KHz	:	12 dB
Channel separation	1KHz	:	35 dB
CD/TAPE sensitivity		:	200mV

TUNER - FM section

Tuning range	:	87.5 -108MHz	
IF frequency	:	10.7MHz	
Sensitivity	:	< 20 dBf at 26 dB S/N	
Selectivity	:	> 40 dB at 600 Khz B.W.	
IF rejection	:	> 70 dB	
Image rejection	:	> 70 dB	
Auto search stop sensitivity	:	> 34 dBf	
Stereo separation	1 KHz	:	> 28 dB

TUNER - AM section

Tuning range	:	522 - 1611KHz
IF frequency	:	450 KHz
Sensitivity	:	< 1000 μ V/m at 20dB S/N
Selectivity	:	> 20 dB
IF rejection	:	> 30 dB
Image rejection	:	> 28 dB
Auto search stop sensitivity	:	< 1585 μ V/m

TUNING BOARD - CIRCUIT DIAGRAM

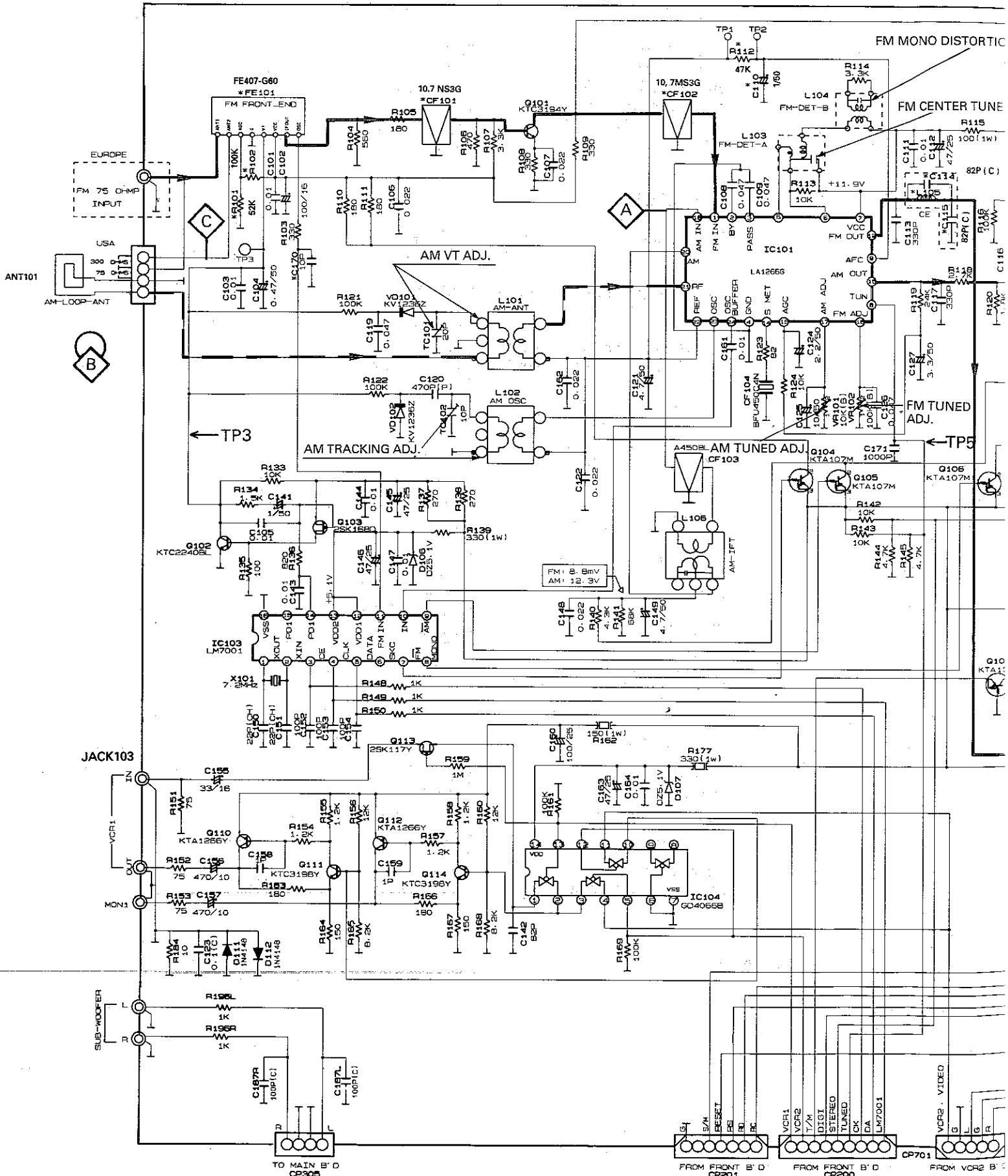

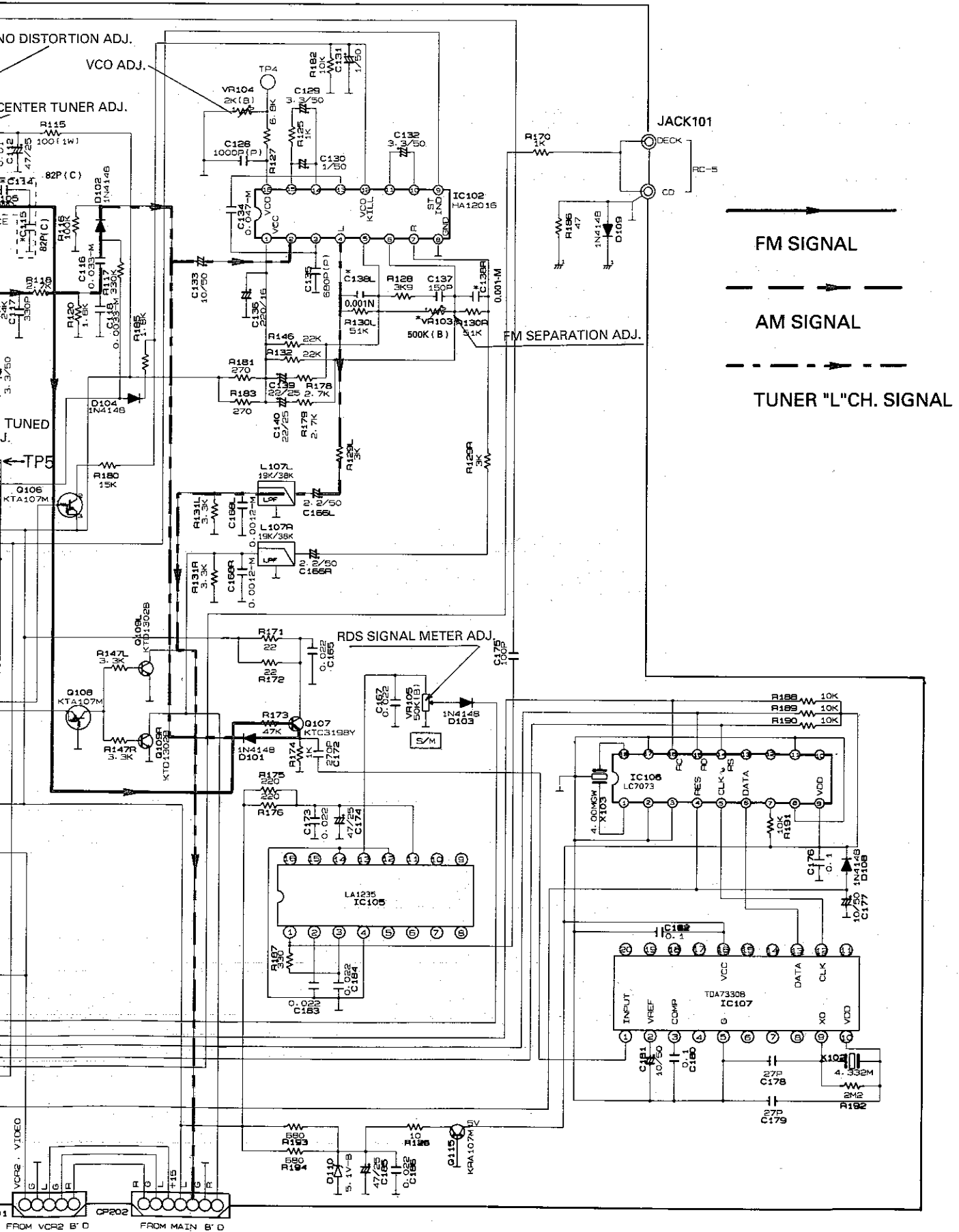

AM
A
AM
MW
TUN
VOL
MW
RF SEN
MW
AUTO
SENSI
FM
FM
FM
FM
AUTO
SENSI
FM
VC
SEPER

* Mod.
75KHZ

RADIO ALIGNMENT

AM IF						
AM	450KHz		999KHz	L106	TAPE OUT	max.
AM RF						
MW (AM) * TUNING VOLTAGE	522KHz		522KHz	L102	TP3	DC voltage 1.0 - 1.2V
	1611KHz		1611KHz	TC102		DC voltage 8.5 - 9.0V
MW (AM)* RF SENSITIVITY	603KHz		603KHz	L101	TAPE OUT	max.
	1404KHz		1404KHz	TC101		
MW (AM) AUTO TUNING SENSITIVITY	999KHz		999KHz	VR101	TAPE OUT	AM SSG Output level of 800µV/m
FM IF						
FM #	98.0MHz		98.0MHz	L103	TP1/TP2 (R112)	Zero voltage
				L104	TAPE OUT	Min. distortion
FM RF						
FM # AUTO TUNING SENSITIVITY	98.0MHz		98.0MHz	VR102	TAPE OUT	FM SSG Output level of 7µV/m
FM MPX						
VCO	98MHz Pilot off		98MHz	VR804	TP4	Frequency 76 ± 0.2KHz
SEPERATION	98MHz (L-channel)		98MHz	VR103	TAPE OUT R-ch	Seperation Betten than 28dB
	98MHz (R-channel)		98MHz		TAPE OUT L-ch	

* Mod. 1KHz 30%

75KHz dev.

"Bei notwendigem Abgleich ist das Gerät auf die gesetzlich vorgeschriebenen Eckfrequenzen abzugleichen".

Repeat

TUNING BOARD - LAYOUT DIAGRAM

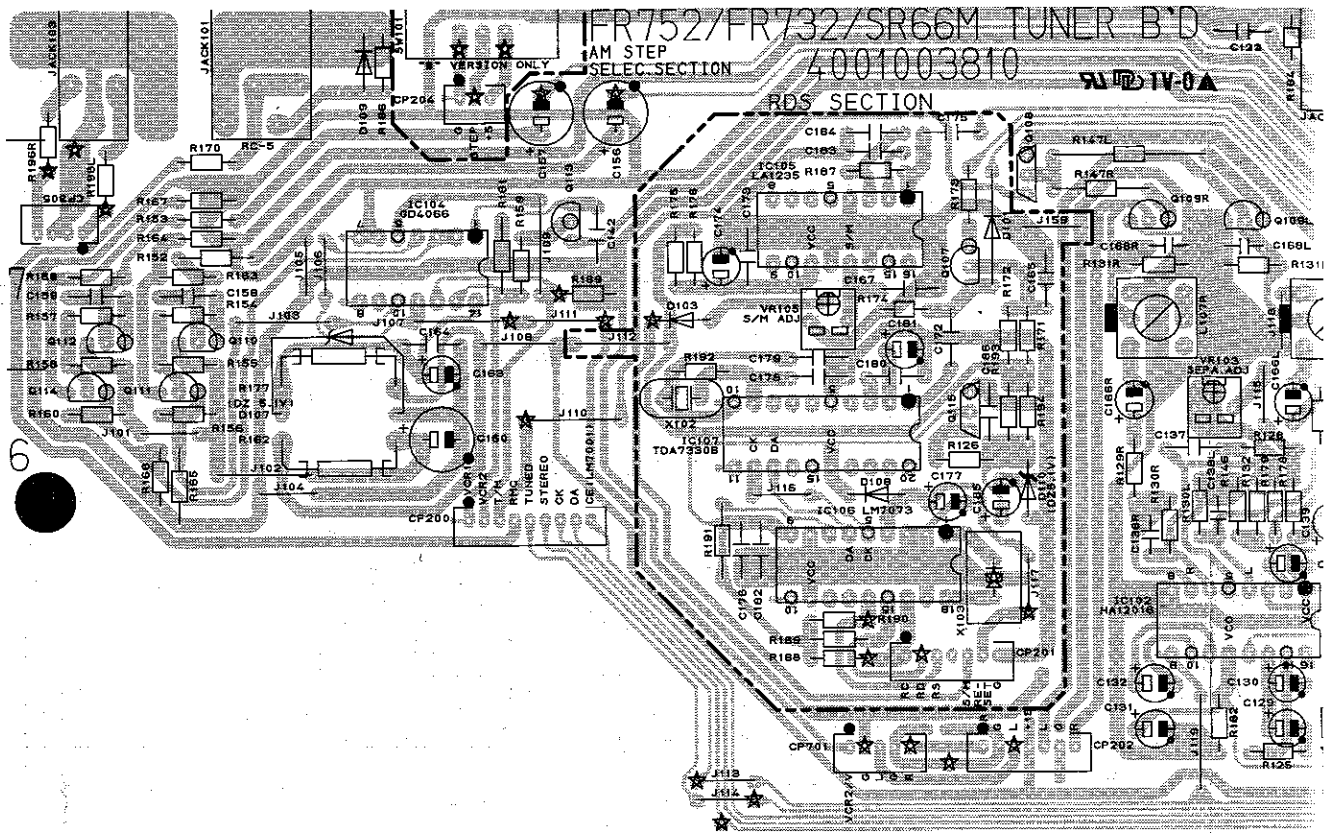

VCR2 BOARD - CIRCUIT DIAGRAM

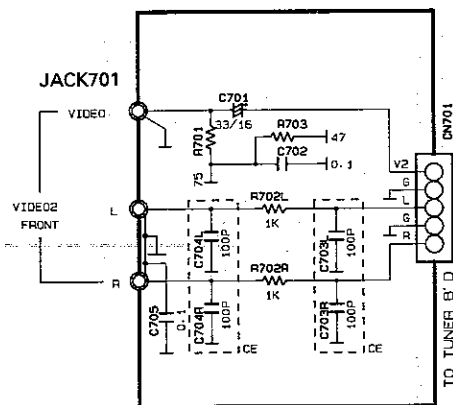

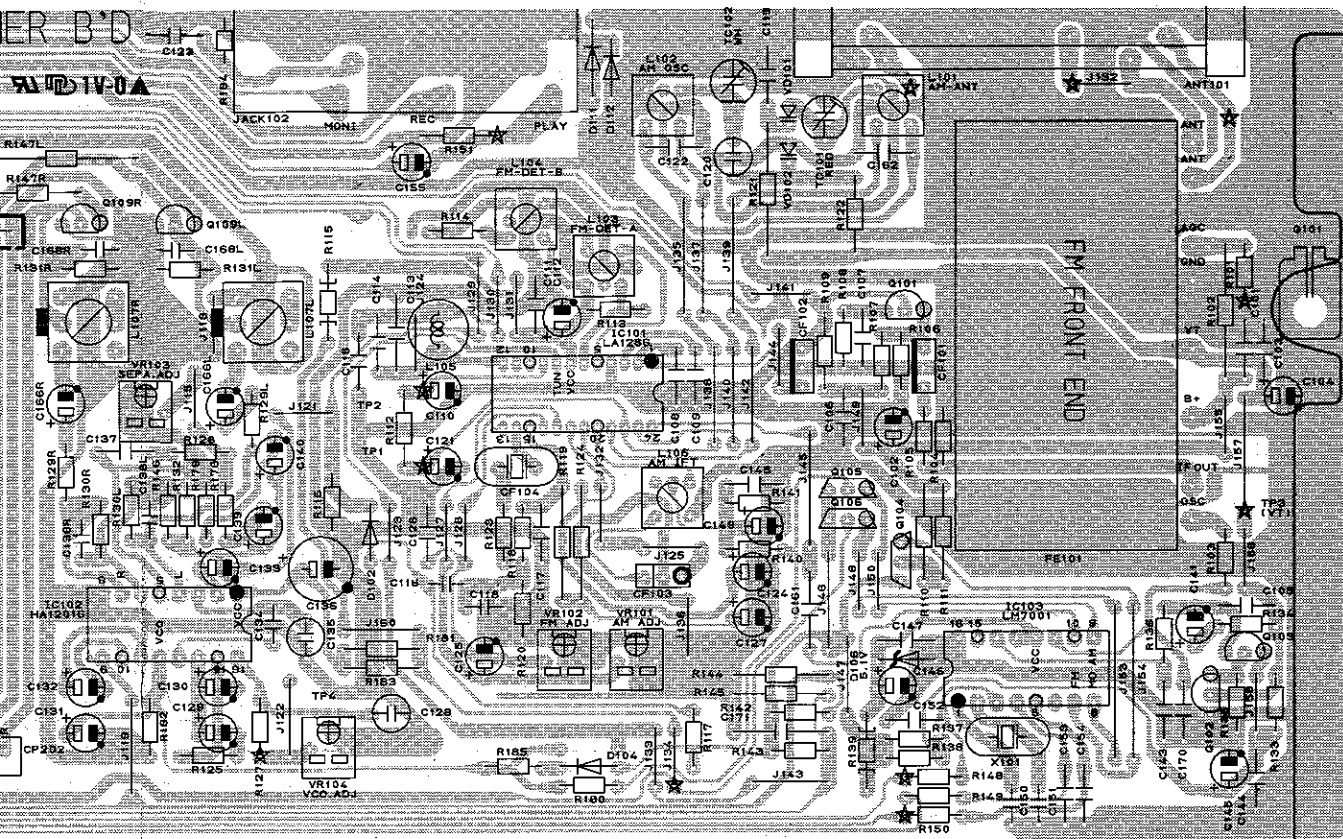

VCR2 BOARD - LAYOUT DIAGRAM

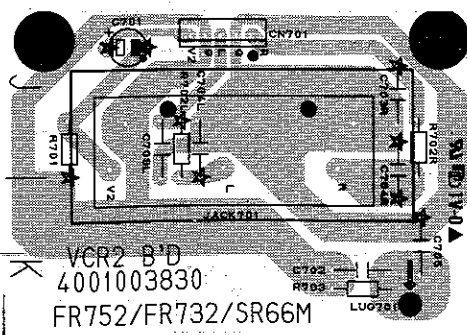

FRONT BOARD - CIRCUIT DIAGRAM

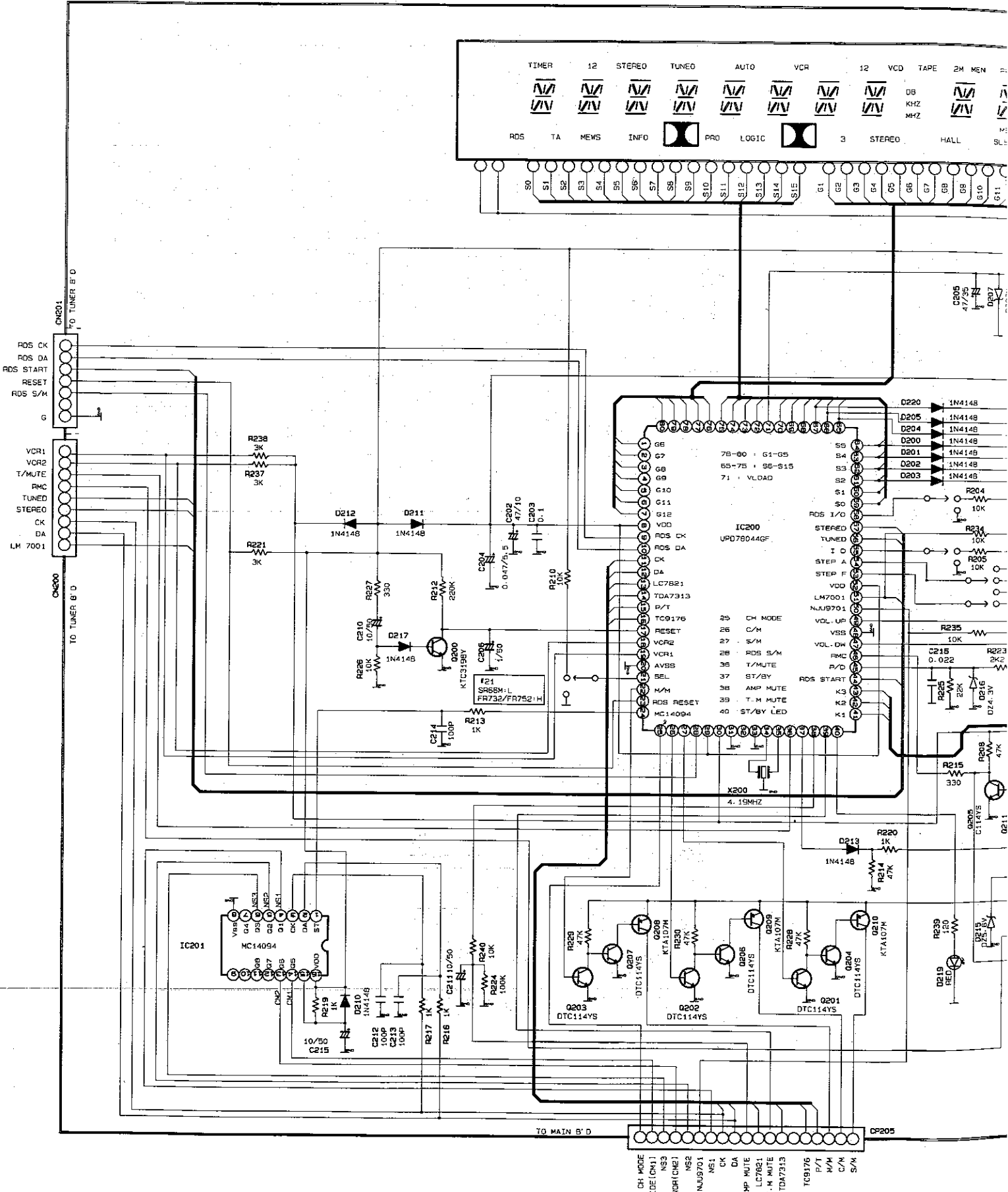

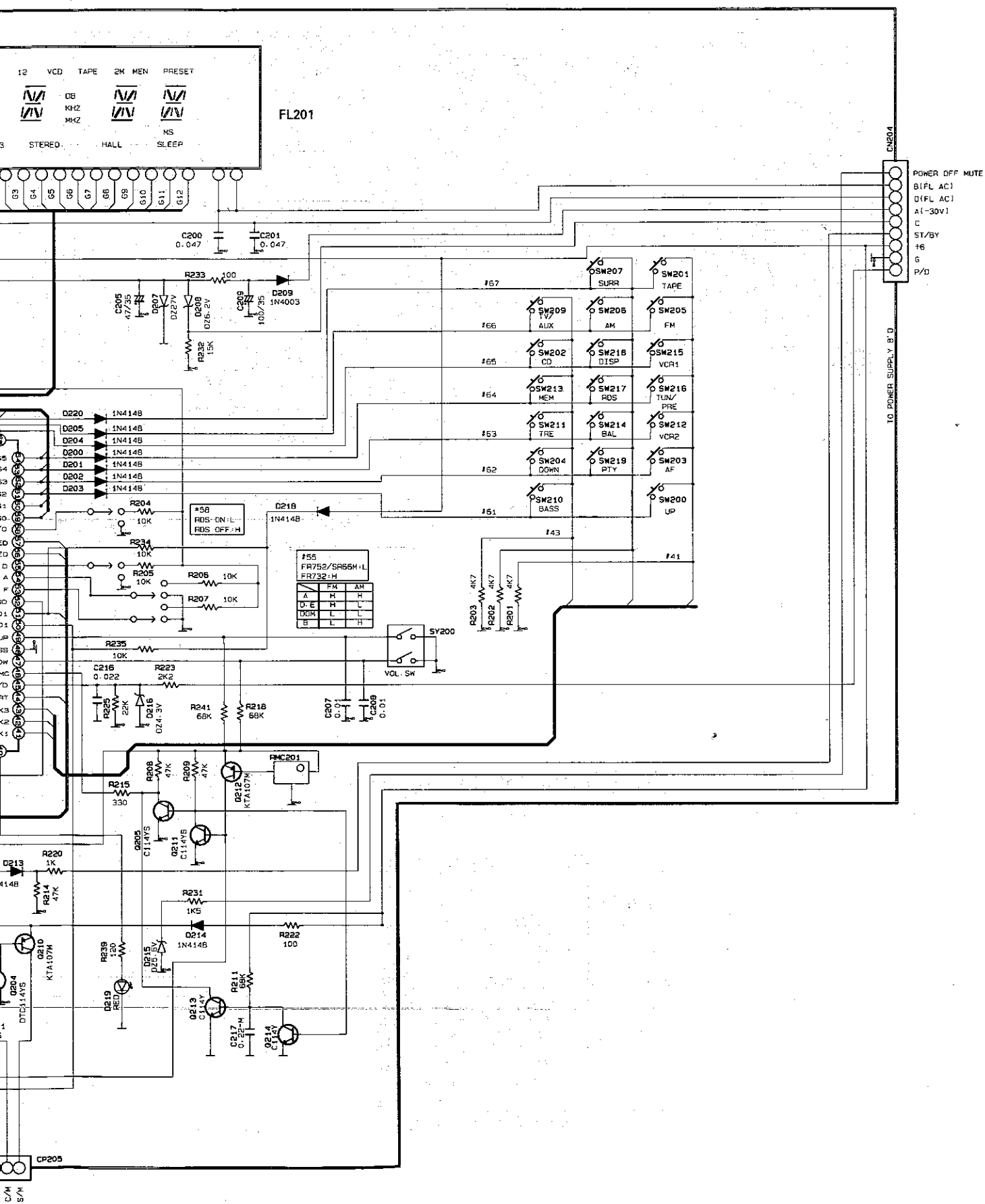

FL201

	FM	AM
A	H	H
D-E	H	L
DOWN	L	L
B	L	H

CP205

TO POWER SUPPLY B-D

- POWER OFF MUTE
- BIFL AC1
- DIFL AC1
- A1-30V1
- C
- ST/BY
- 16
- G
- P/D

FRONT BOARD - LAYOUT DIAGRAM

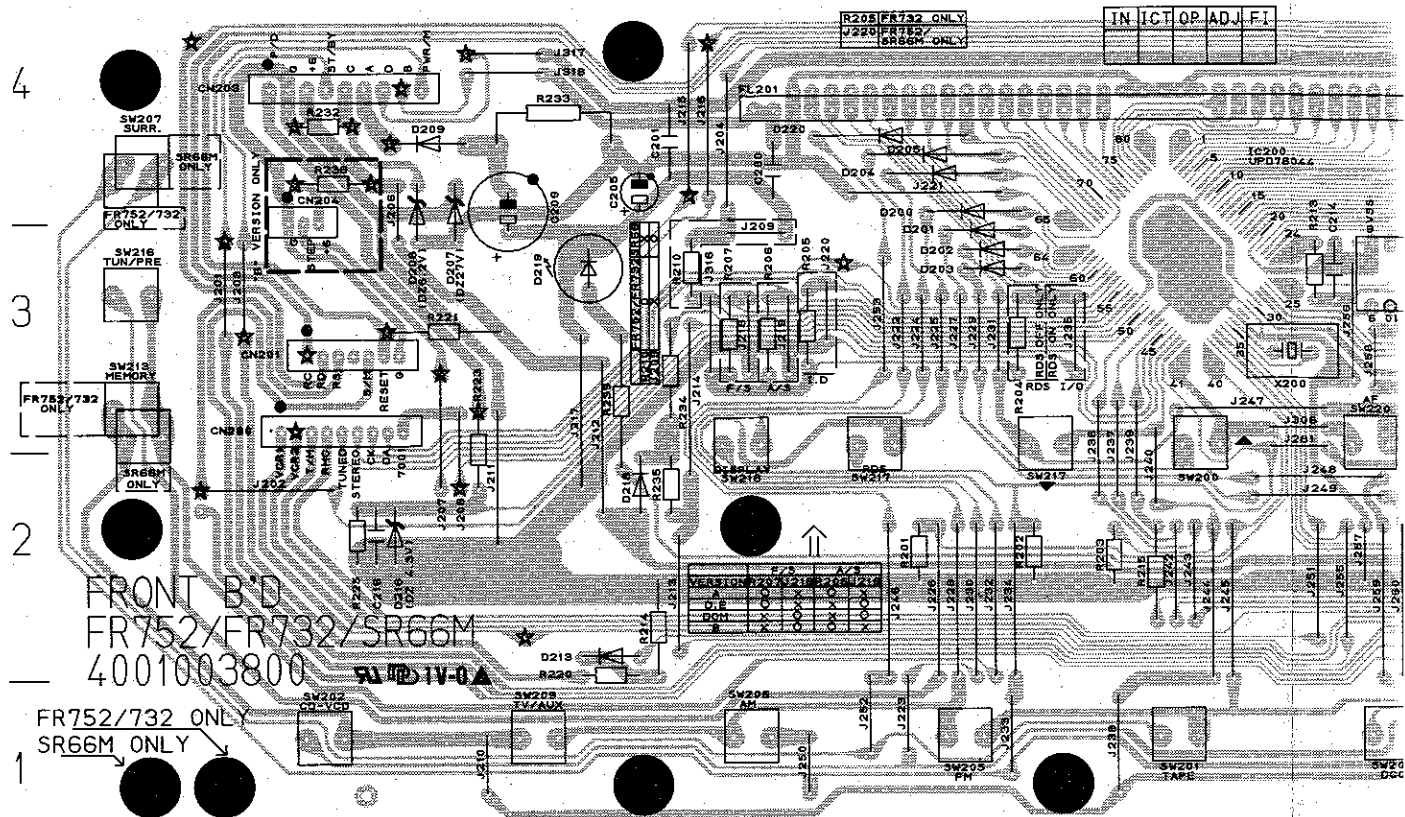

POWER SWITCH BOARD - CIRCUIT DIAGRAM

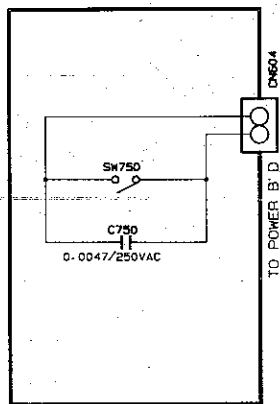

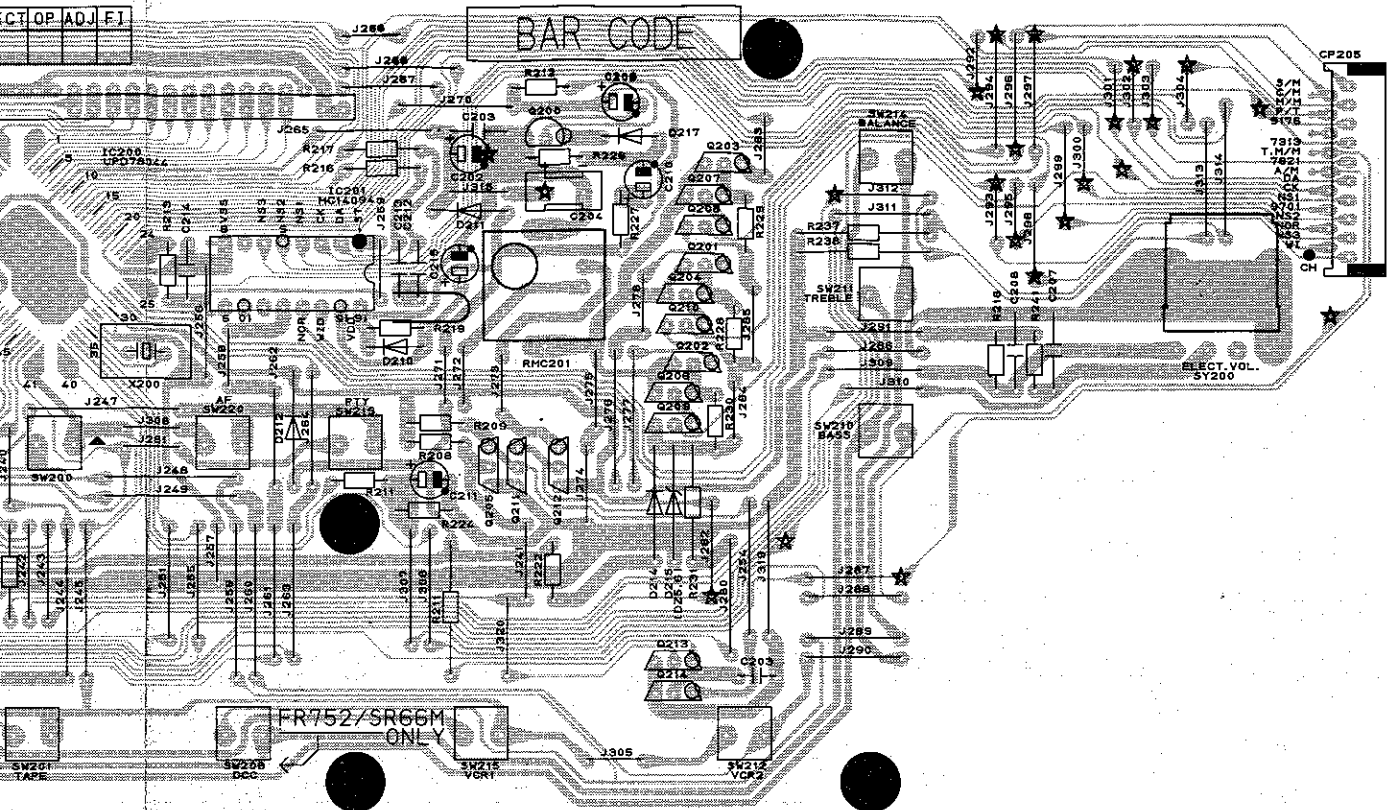

POWER SWITCH BOARD - LAYOUT DIAGRAM

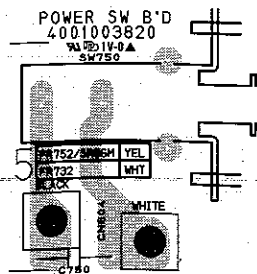

MAIN BOARD - CIRCUIT DIAGRAM

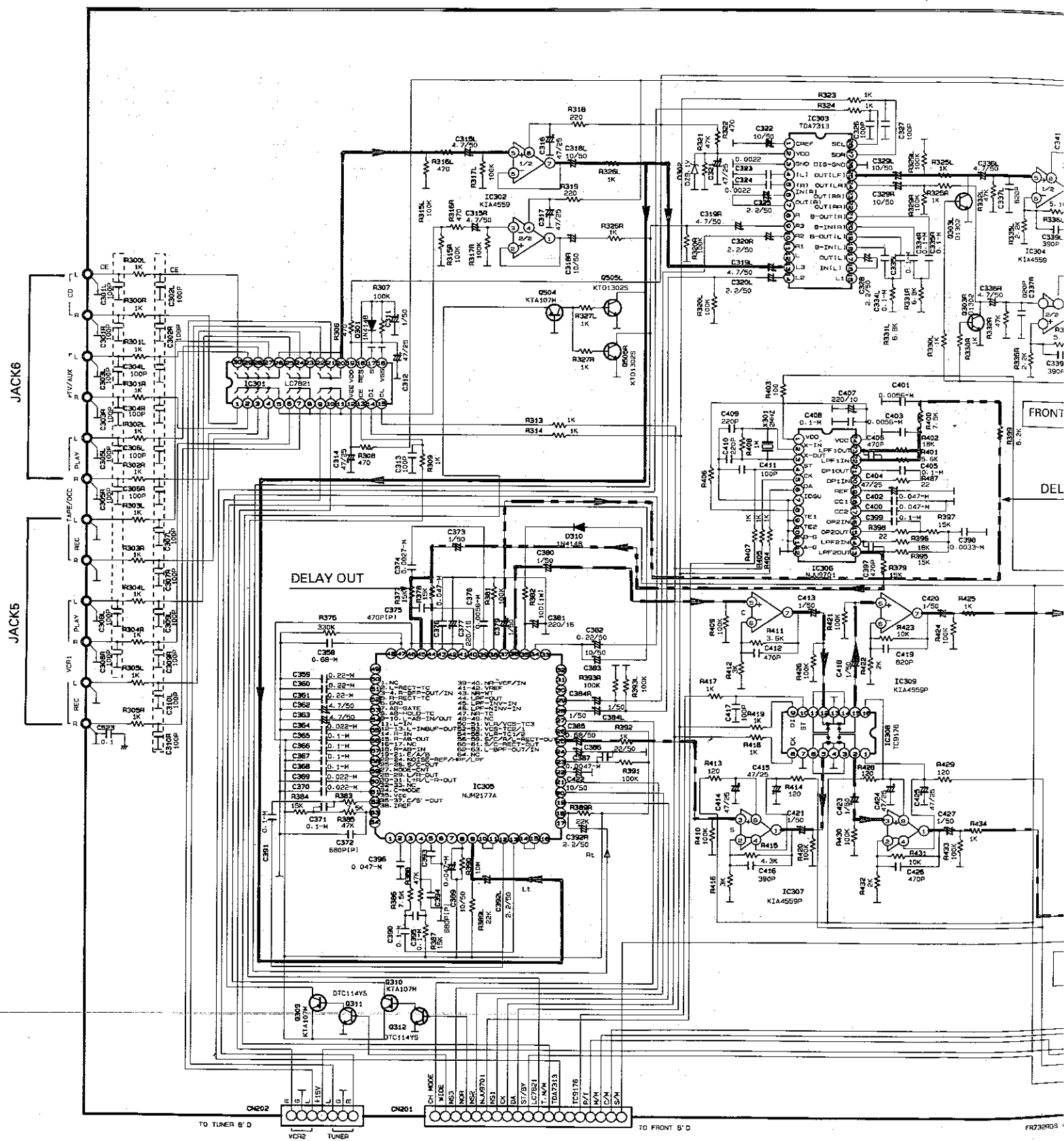

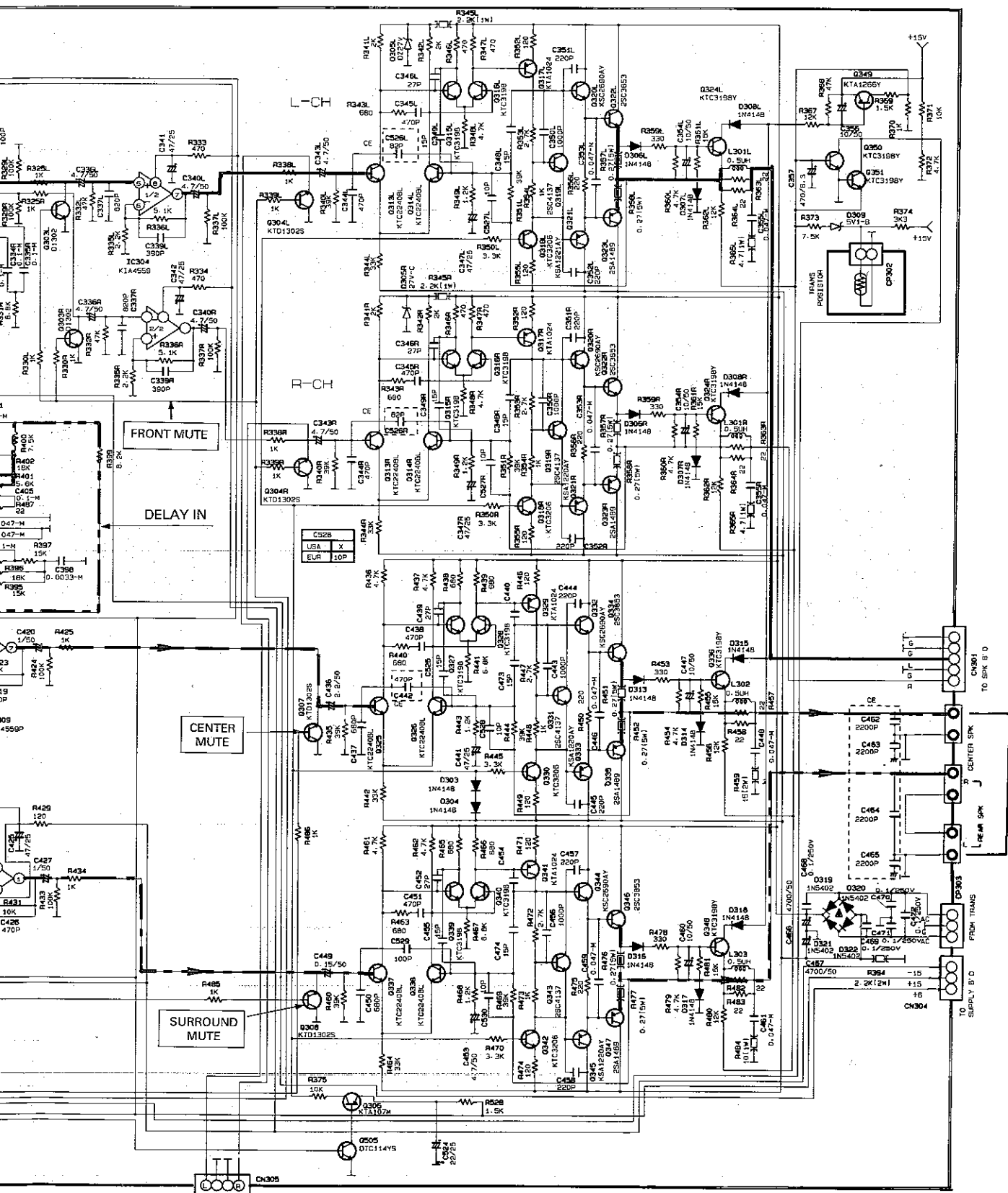

FR739RDS ONLY TO TUNER B'D

- FRONT "L"CH. SIGNAL
- CENTER SIGNAL
- SURROUND SIGNAL

MAIN BOARD - LAYOUT DIAGRAM

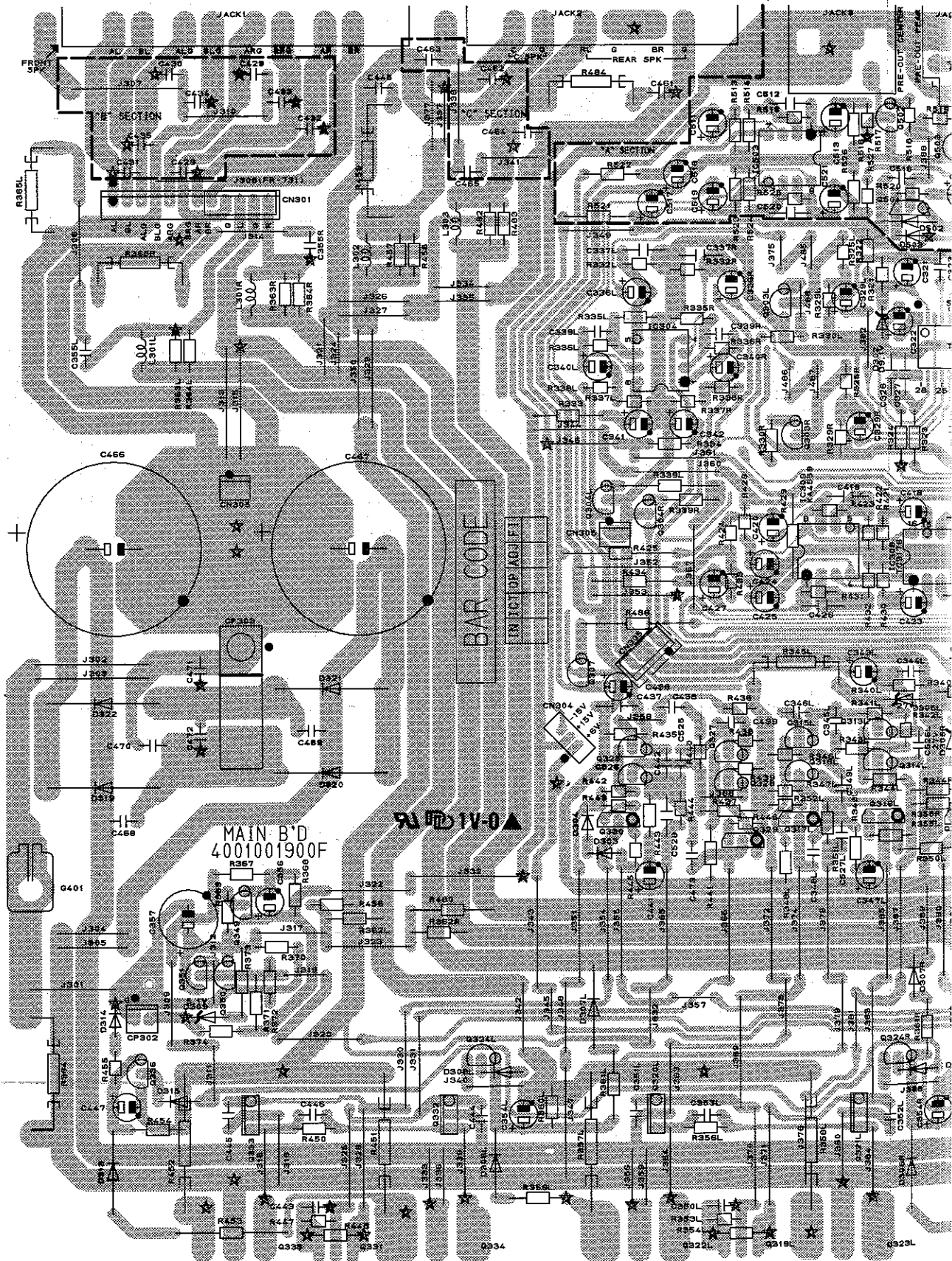

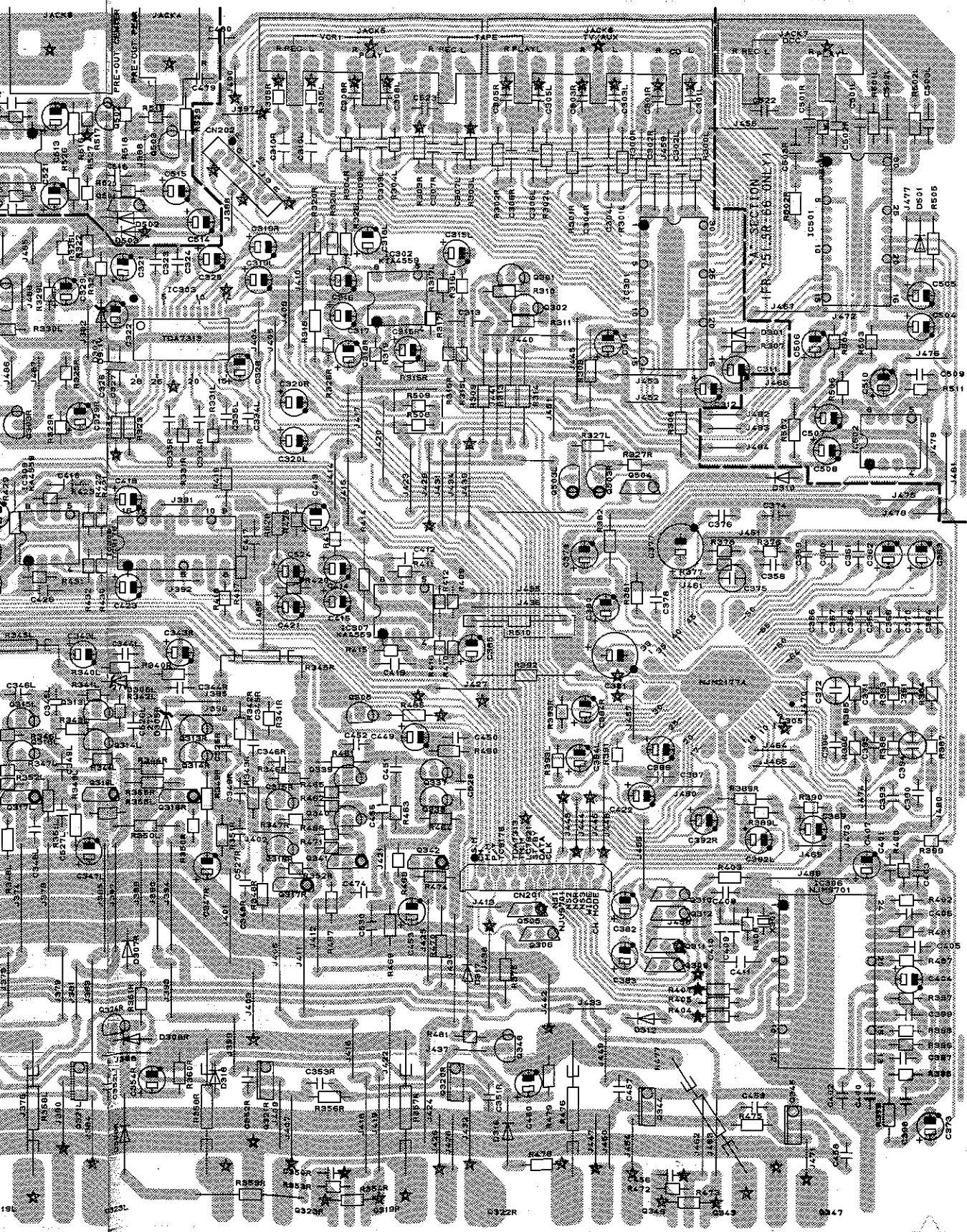

HEADPHONE BOARD - CIRCUIT DIAGRAM

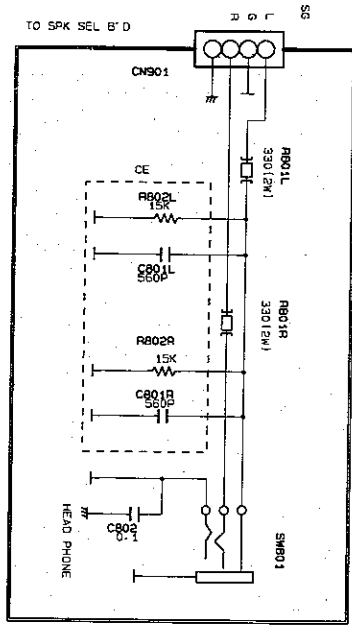

POWER SUPPLY BOARD

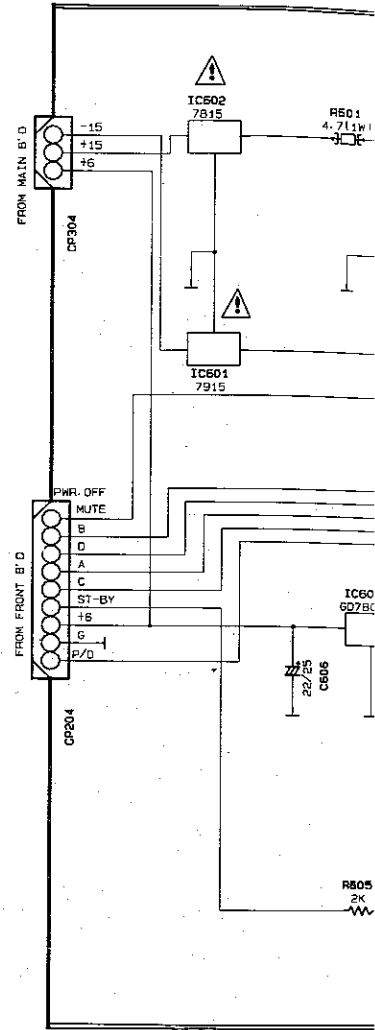

SPEAKER BOARD - CIRCUIT DIAGRAM (FR732 ONLY)

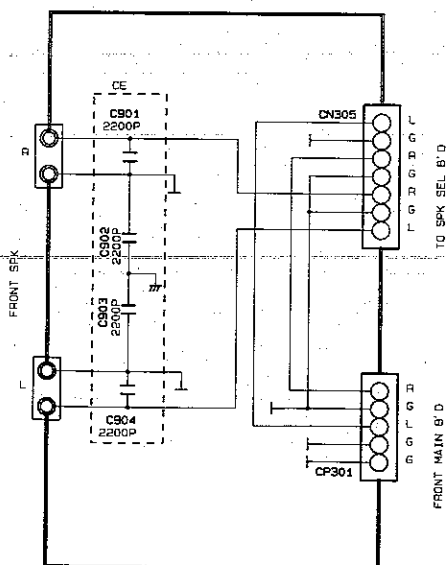

SPEAKER SELECTOR

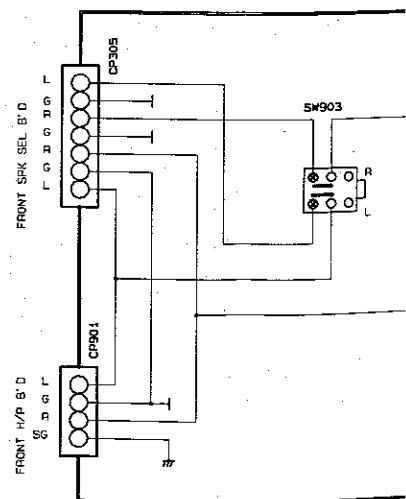

ER SUPPLY BOARD - CIRCUIT DIAGRAM

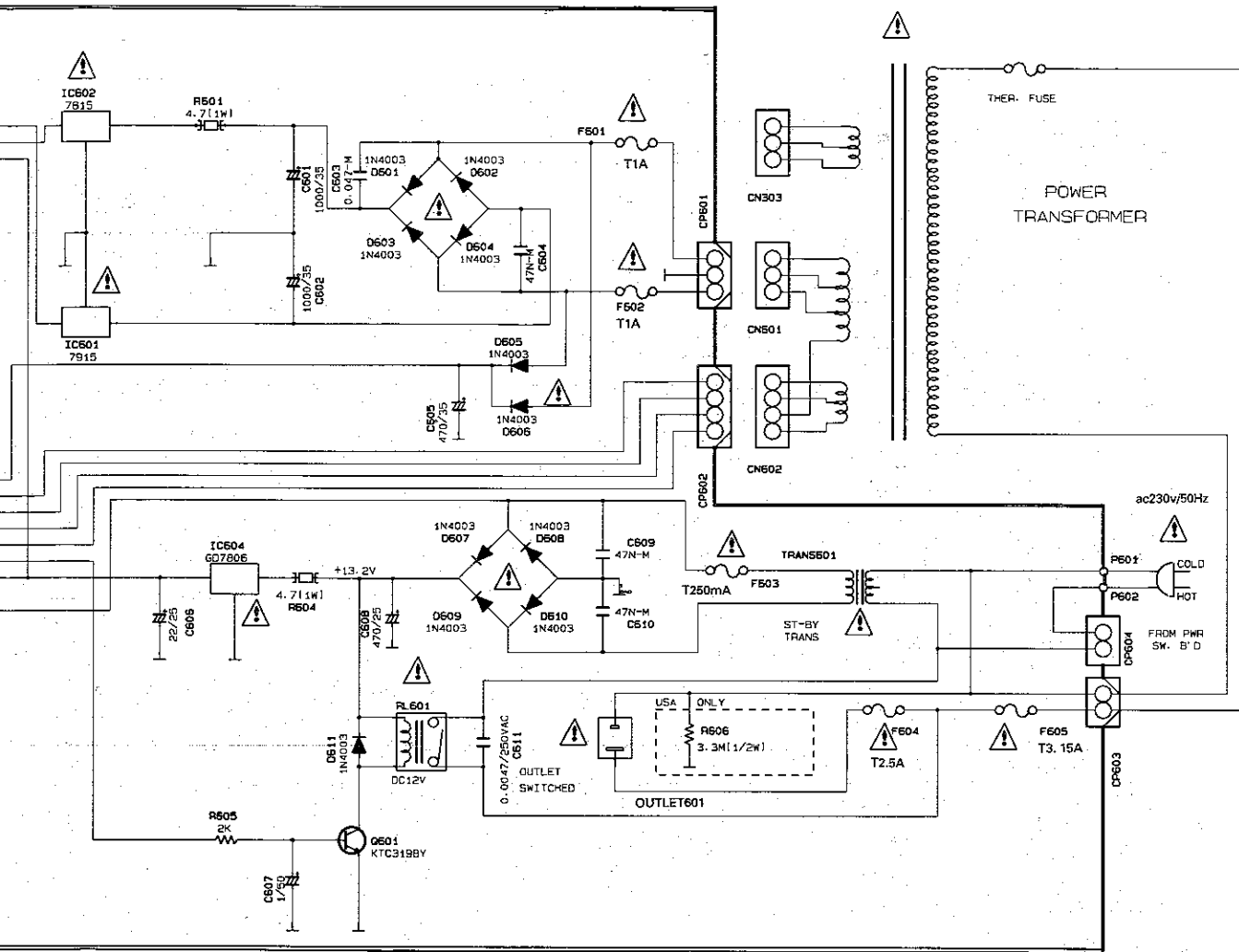

AKER SELECTOR BOARD - CIRCUIT DIAGRAM (FR732 ONLY)

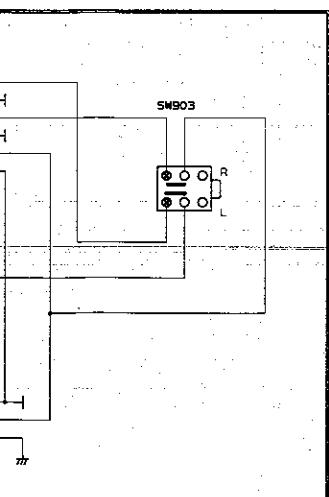

HEADPHONE BOARD - LAYOUT DIAGRAM

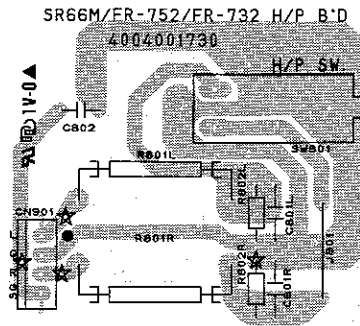

SPEAKER BOARD - LAYOUT DIAGRAM (FR732 ONLY)

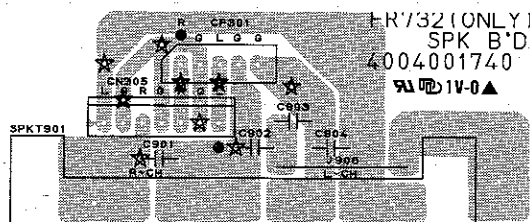

POWER SUPPLY BOARD - LAYOUT DIAGRAM

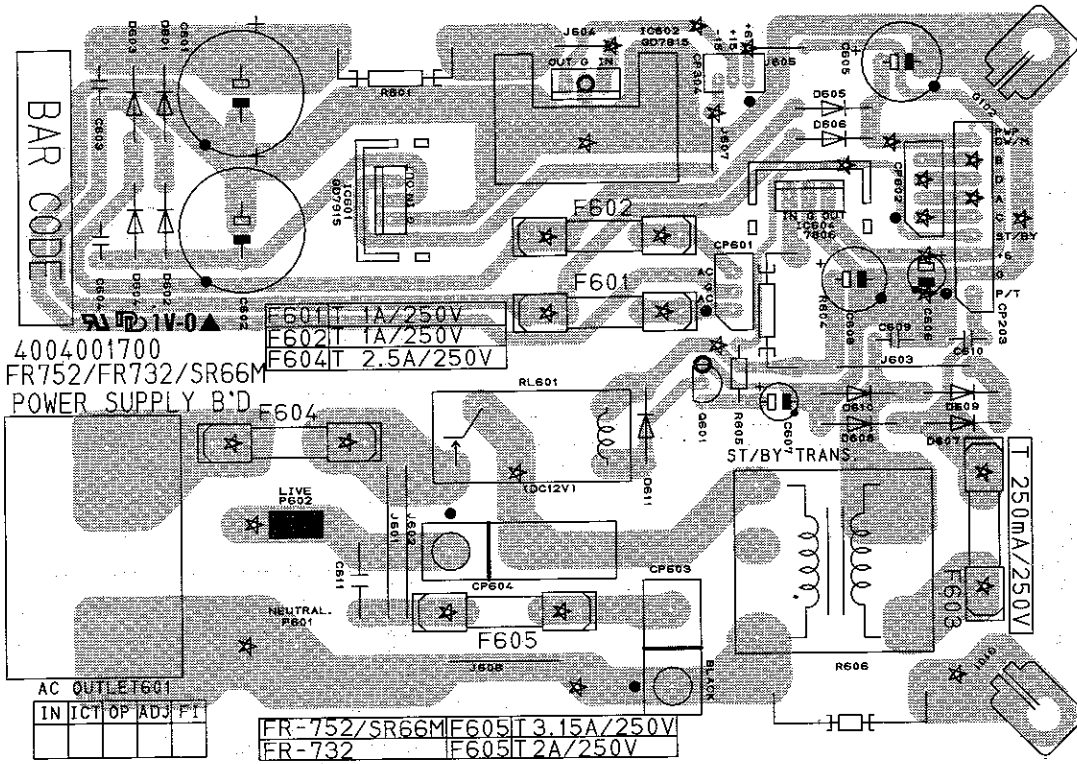

SPEAKER SELECTOR BOARD - LAYOUT DIAGRAM (FR732 ONLY)

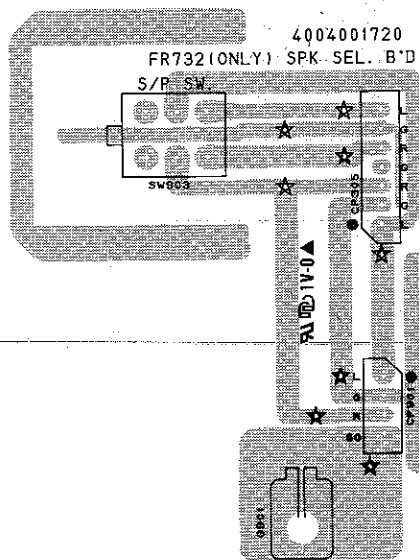

SERVICE TEST PROGRAM - μ PD78044AGF

IC200 : μ PD 78044AGF (8bit CMOS Microprocessor)

1. Pin Configuration

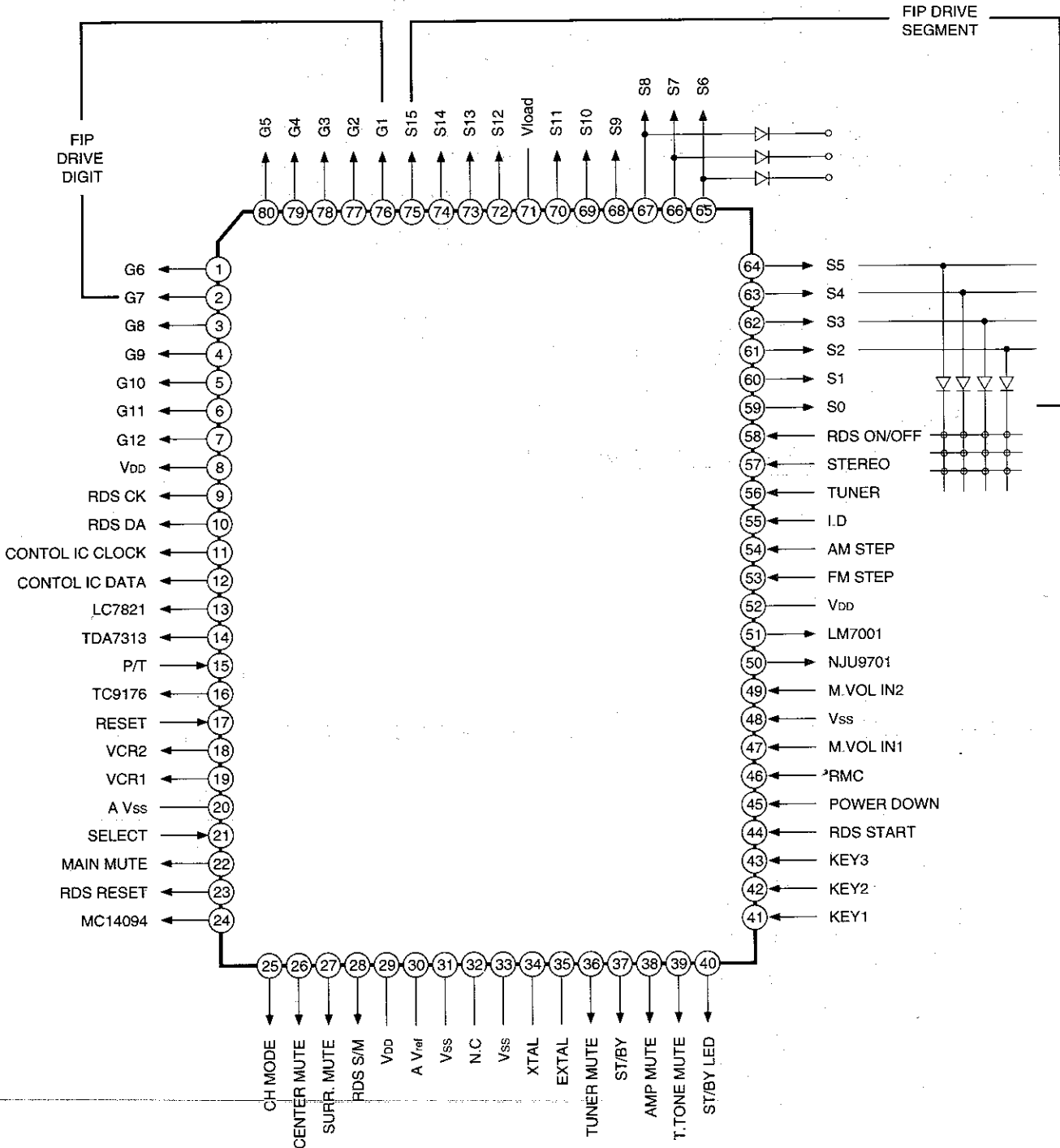

2. Key

IN
KEY PII
KEY PII
KEY PII

3. Bio

2. Key Matrix

OUT IN	K. SCAN2 PIN61	K. SCAN3 PIN62	K. SCAN4 PIN63	K. SCAN5 PIN64	K. SCAN6 PIN65	K. SCAN7 PIN66	K. SCAN8 PIN67
KEY IN1 PIN41	TUNING UP	AF	VCR2	TUNING PRESET	VCR1	FM	TAPE
KEY IN2 PIN42		PTY	BALANCE	RDS	DISPLAY	AM	SURR.
KEY IN3 PIN43	KEY IN43 PIN43	TUNING DOWN	TREBLE	MEMORY	CD	AUX	-

3. Block Diagram

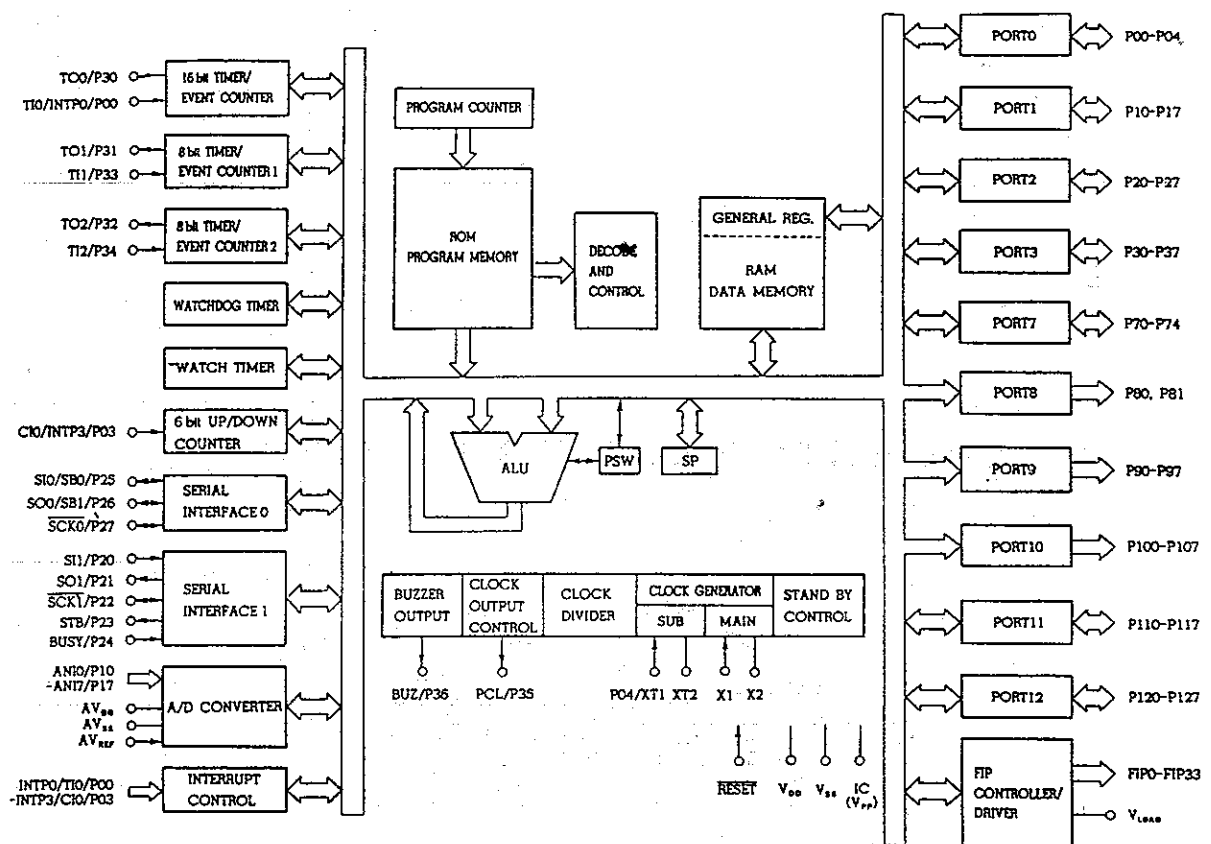

SERVICE TEST PROGRAM - μ PD78044AGF

4. Input/Output Terminal Functions

Pin No.	Symbol	Description																
1~7	$G_6 \sim G_{12}$	Grid signal output for FIP.																
8	V_{DD}	+5V power supply.																
9/10	RDS CLK/DATA	RDS CLOCK/DATA input for LC7073.																
11/12	CLK/DATA	CLOCK/DATA output for TDA7313, TC9176, NJU9701, LC7821, LM7001 and MC14094.																
13	LC7821	Chip enable output for LC7821.																
14	TDA7313	Chip enable output for TDA7313.																
15	PROTECTION	Signal input for protection. If it is low, all channel mute signal levels are turned to high to protect speakers and this unit. At abnormal condition, after 3 seconds elapses, it does check protection.																
16	TC9176	Chip enable output for TC9176.																
17	RESET	Input for resetting CPU. (At "H", it is active)																
18/19	VCR IN 1 /VCR IN 2	Output to select the video signal VCR1 or VCR2. Output data for each mode is as follows. <table border="1" style="margin-left: 20px;"> <thead> <tr> <th>MODE</th> <th>VCR IN 1</th> <th>VCR IN 2</th> <th>REMARKS</th> </tr> </thead> <tbody> <tr> <td>VCR 1</td> <td>H</td> <td>L</td> <td>Initial settings</td> </tr> <tr> <td>VCR 2</td> <td>L</td> <td>H</td> <td></td> </tr> <tr> <td>OTHERS</td> <td>Δ</td> <td>Δ</td> <td>Δ: Previous state</td> </tr> </tbody> </table> <p>※ Last memory function is available</p>	MODE	VCR IN 1	VCR IN 2	REMARKS	VCR 1	H	L	Initial settings	VCR 2	L	H		OTHERS	Δ	Δ	Δ : Previous state
MODE	VCR IN 1	VCR IN 2	REMARKS															
VCR 1	H	L	Initial settings															
VCR 2	L	H																
OTHERS	Δ	Δ	Δ : Previous state															
20	A.Vss	Analog ground																
21	SELECTOR	Input to select FR-732RDS. (At "H", it is active)																
22	MAIN MUTE	Output for main mute. Output is low level under the following conditions. 1. When power is turned on or off. 2. When function is changed. 3. When "- ∞ mute signal" is received from the commander.																
23	RDS RESET	Input to select LC7073.																
24	MC14094 STROBE	Chip enable output for MC14094.																
25	CH. MODE	Output for setting of PRO-LOGIC ,3-STEREO mode. According to each mode, data output is as follows. <table border="1" style="margin-left: 20px;"> <thead> <tr> <th>MODE</th> <th>OUTPUT</th> </tr> </thead> <tbody> <tr> <td>3-STEREO</td> <td>High impedance</td> </tr> <tr> <td>PRO-LOGIC</td> <td>H</td> </tr> <tr> <td>OTHERS</td> <td>L</td> </tr> </tbody> </table>	MODE	OUTPUT	3-STEREO	High impedance	PRO-LOGIC	H	OTHERS	L								
MODE	OUTPUT																	
3-STEREO	High impedance																	
PRO-LOGIC	H																	
OTHERS	L																	
26	CENTER MUTE	Output for center mute. Output is low level under the following conditions. 1. When power is turned on or off. 2. When center mode is turned on or off. 3. When center mode is switched. 4. When test tone mode is switched on, or when output is not directed to center. 5. When "- ∞ mute signal" is received from the commander.																

Pin No.	Symbol	Description
27	SURR. MUTE	Output for surround mute. Output is low level under the following conditions. 1. When power is turned on or off. 2. When surround mode is turned on or off. 3. When test tone mode is changed, or when output is not directed to surround. 4. When delay time is activated. 5. When "-∞ mute signal" is received from the commander.
28	RDS S/M	Input to detect the signal strength of RDS station.
29	V _{DD}	+5V power supply.
30	A.Vref	Reference voltage.(Connected to +5V, Not V _{DD})
31	V _{SS}	Ground
32	NC	Not used !
33	V _{SS}	Ground
34/35	XTAL/EXTAL	Input and Output for crystal oscillator.
36	TUNER MUTE	Output for tuner mute. Output is high level under the following conditions. 1. When power is turned on or off. 2. When tuner band is changed. 3. When tuning up or down button is pressed. 4. When preset button is pressed. 5. When displayed preset number is changed during memory scan. 6. When "-∞ mute signal" is received from the commander.
37	ST-BY	When the power is on, control data output is "H". When the power is off, control data output is "L" and last memory function is activated.
38	AMP MUTE	Output for all amplifier mute. Output is high level under the following conditions. 1. When power is turned on or off. 2. When the protection terminal's level is high.
39	T.TONE MUTE	Output for PRO-LOGIC test ton mute. Output is high level under the following conditions. When power is turned on or off.
40	ST-BY LED	Output to light up stand-by LED.(At "H", it is active)
41~43	KEY ₁ ~KEY ₃	Input data of K ₁ ~K ₃ for key scan.
44	RDS START	Input for LC7073 data start.
45	POWER DOWN	Input for power down.(At "L", it is active)
46	RMC	Input for remote control signal.(At "L", it is active)
47/49	M.VOL. IN 1/IN 2	Signal input to decrease or increase volume by volume encoder.
48	V _{SS}	Ground
50	NJU9701	Chip enable output for NJU9701.
51	LM7001	Chip enable output for LM7001.
52	V _{DD}	+5V power supply.

Pin No.	Symbol	Description																			
53/54	FM/AM STEP	According to region, input for selecting the frequency band and the steps of FM and AM. Settings are as follows.																			
		<table border="1"> <thead> <tr> <th>REGION</th> <th>STEP</th> <th>BAND</th> <th>Pin 53</th> <th>Pin 54</th> </tr> </thead> <tbody> <tr> <td rowspan="2">USA/CANADA</td> <td>100 kHz</td> <td>FM</td> <td rowspan="2">H</td> <td rowspan="2">H</td> </tr> <tr> <td>10 kHz</td> <td>AM</td> </tr> <tr> <td rowspan="2">EUROPE</td> <td>50 kHz</td> <td>FM</td> <td rowspan="2">H</td> <td rowspan="2">L</td> </tr> <tr> <td>9 kHz</td> <td>AM</td> </tr> </tbody> </table>	REGION	STEP	BAND	Pin 53	Pin 54	USA/CANADA	100 kHz	FM	H	H	10 kHz	AM	EUROPE	50 kHz	FM	H	L	9 kHz	AM
		REGION	STEP	BAND	Pin 53	Pin 54															
		USA/CANADA	100 kHz	FM	H	H															
			10 kHz	AM																	
EUROPE	50 kHz	FM	H	L																	
	9 kHz	AM																			
55	FR-752RDS /FR-732RDS ID	Input for selecting FR752RDS or FR732RDS mode. According to each mode, data input is as follows.																			
		<table border="1"> <thead> <tr> <th>MODE</th> <th>INPUT</th> </tr> </thead> <tbody> <tr> <td>FR752RDS</td> <td>L</td> </tr> <tr> <td>FR732RDS</td> <td>H</td> </tr> </tbody> </table>	MODE	INPUT	FR752RDS	L	FR732RDS	H													
		MODE	INPUT																		
FR752RDS	L																				
FR732RDS	H																				
56	TUNED	Input for detecting station during tuning. If "L" is inputted during turning, turning stops at that frequency.																			
57	STEREO	Input for lighting the STEREO indicator. (At "L", it is active)																			
58	RDS ON/OFF	Input for RDS on or off. (RDS on: "L", RDS off: "H")																			
59~70	S ₀ ~S ₁₁	Segment signal output for FIP.																			
71	Vload	-27V power supply for FIP.																			
72~75	S ₁₂ ~S ₁₅	Segment signal output for FIP.																			
76~80	G ₁ ~G ₅	Grid signal output for FIP.																			

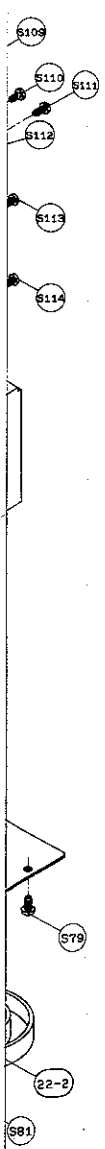

EXPLODED VIEW DIAGRAM

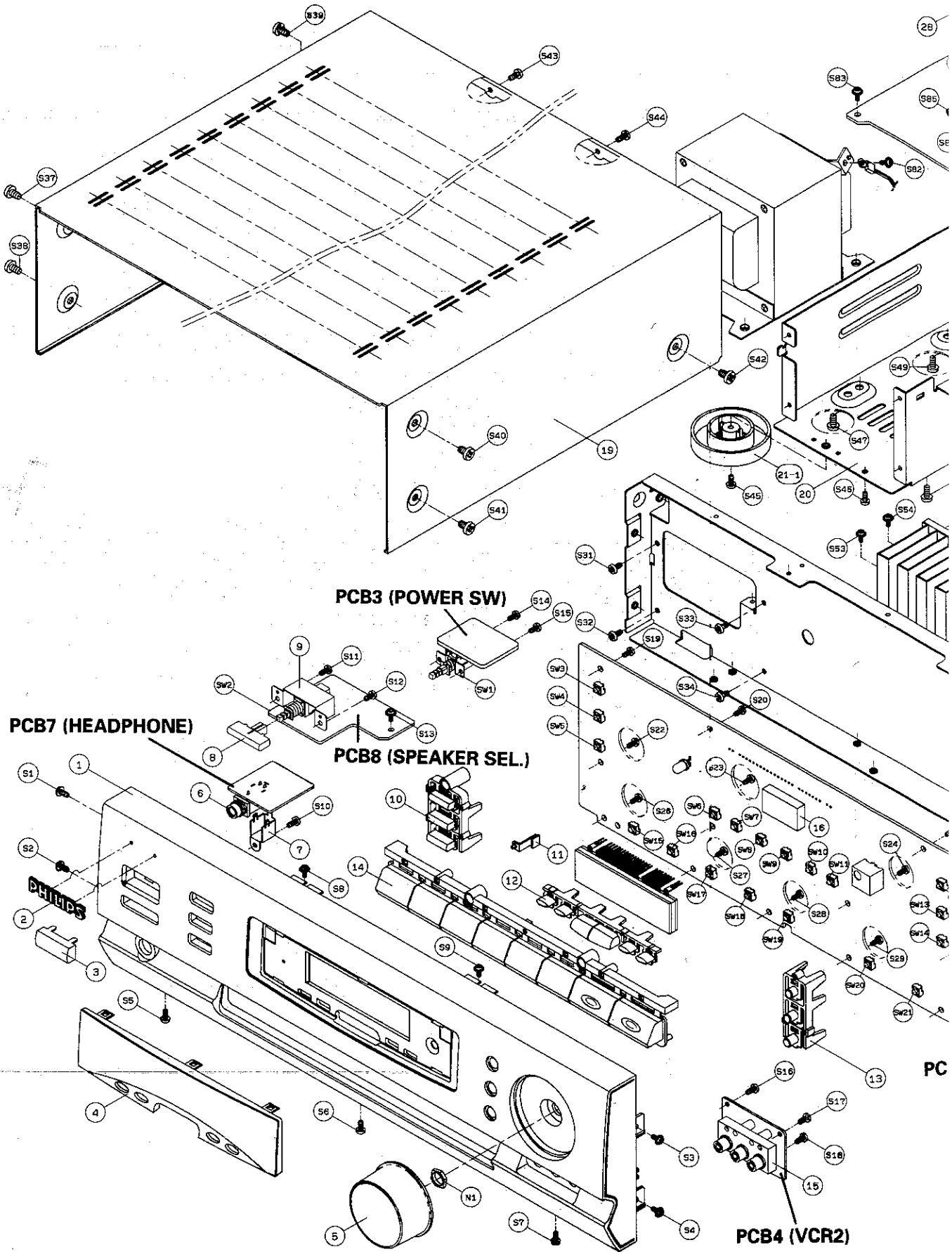

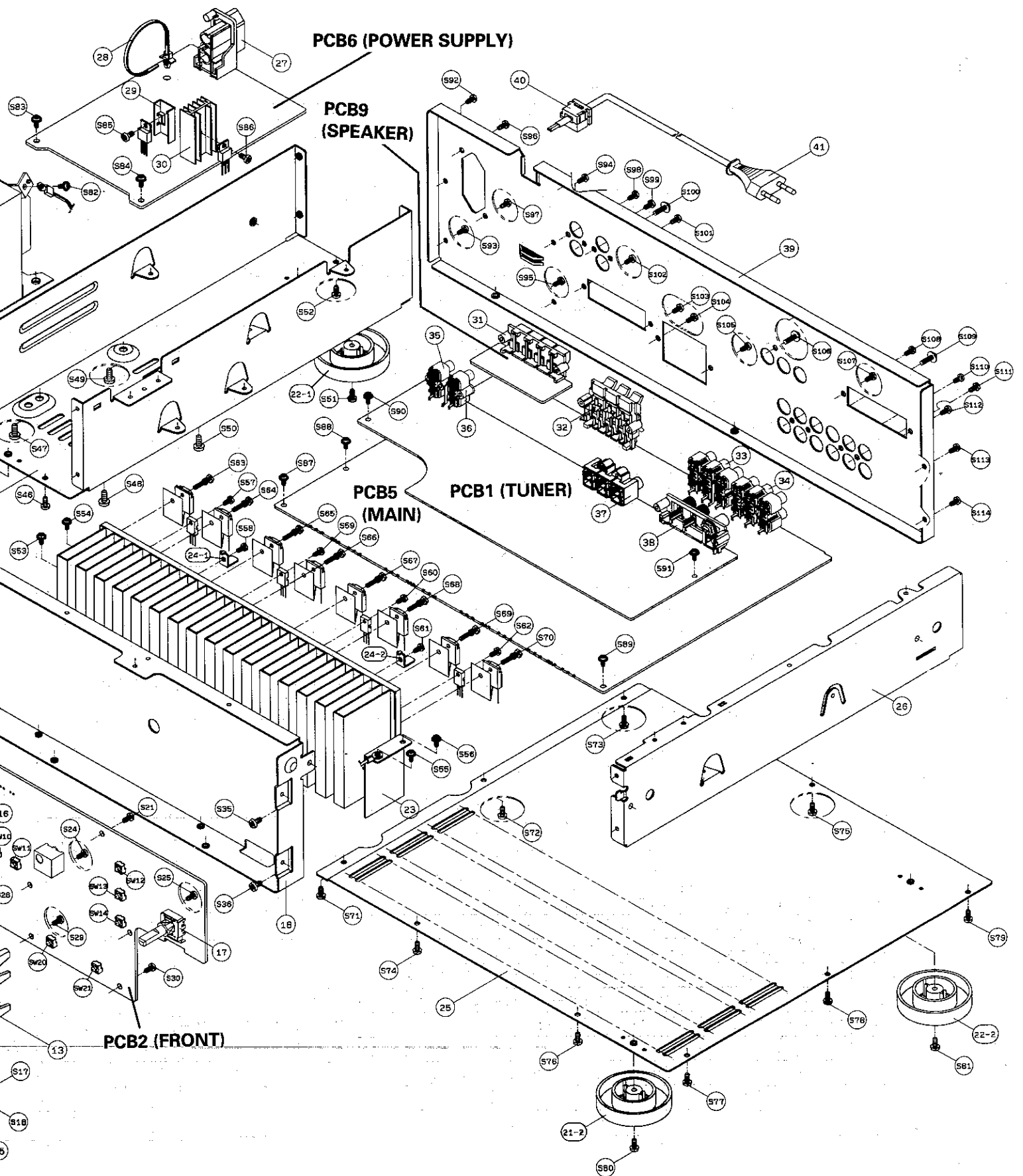

CR2)

MECHANICAL PARTSLIST

1	4822 459 04369	Front Panel
2	4822 459 11262	Badge (Philips)
3	4822 410 10799	Power Button
4	4822 450 10212	Window Display
5	4822 413 51525	Knob Main Volume
8	4822 410 63968	Push Button
10	4822 410 63967	Surrond Button
11	4822 381 11651	LED Indicator
12	4822 410 10801	Station Button
13	4822 413 41931	Tone Button
14	4822 410 63969	Function Button
17	4822 277 11645	Switch Encoder
21	4822 462 42232	Foot (Silver)
22	4822 462 42233	Foot (Black)
25	4822 462 10816	Cover Button
40	4822 325 80544	Stopper Cord
41	4822 321 10527	AC Power Cord
	4822 218 10599	Remote Commander Assy
	4822 736 14707	Instruction Manual

Note : Only those parts mentioned in the list are normal service parts.

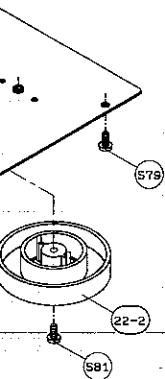
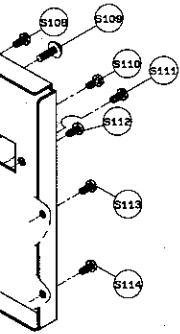

MAIN BOARD

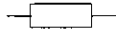

R357L	4822 117 11964	Cement Rst 0.27Ω 5W
R357R	4822 117 11964	Cement Rst 0.27Ω 5W
R358L	4822 117 11964	Cement Rst 0.27Ω 5W
R358R	4822 117 11964	Cement Rst 0.27Ω 5W
R451	4822 117 11964	Cement Rst 0.27Ω 5W
R452	4822 117 11964	Cement Rst 0.27Ω 5W
R476	4822 117 11964	Cement Rst 0.27Ω 5W
R477	4822 117 11964	Cement Rst 0.27Ω 5W

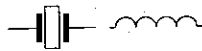

L301L	4822 157 71892	Coil Ind 0.5μH
L301R	4822 157 71892	Coil Ind 0.5μH
L302	4822 157 71892	Coil Ind 0.5μH
L303	4822 157 71892	Coil Ind 0.5μH
X301	4822 242 81969	CSA2.00MG-TF01



D301	4822 130 30621	Diode 1N4148
D302	4822 130 70048	Zener UZ9.1BSC
D303	4822 130 30621	Diode 1N4148
D304	4822 130 30621	Diode 1N4148
D305L	4822 130 70048	Zener UZ27.0BSC
D305R	4822 130 70048	Zener UZ27.0BSC
D306L	4822 130 30621	Diode 1N4148
D306R	4822 130 30621	Diode 1N4148
D307L	4822 130 30621	Diode 1N4148
D307R	4822 130 30621	Diode 1N4148
D308L	4822 130 30621	Diode 1N4148
D308R	4822 130 30621	Diode 1N4148
D309	4822 130 70044	Zener UZ5.1BSB
D310	4822 130 30621	Diode 1N4148
D311	4822 130 30621	Diode 1N4148
D312	4822 130 30621	Diode 1N4148
D313	4822 130 30621	Diode 1N4148
D314	4822 130 30621	Diode 1N4148
D315	4822 130 30621	Diode 1N4148
D316	4822 130 30621	Diode 1N4148
D317	4822 130 30621	Diode 1N4148
D318	4822 130 30621	Diode 1N4148
D319	4822 130 33765	Rectifier PX6A03
D320	4822 130 33765	Rectifier PX6A03
D321	4822 130 33765	Rectifier PX6A03



D322	4822 130 33765	Rectifier PX6A03
D502	4822 130 30621	Diode 1N4148
D503	4822 130 30621	Diode 1N4148

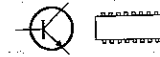

IC301	4822 209 72748	IC LC7821
IC302	4822 209 91029	IC KIA4559P
IC303	4822 209 32995	IC TDA7313
IC304	4822 209 91029	IC KIA4559P
IC305	4822 209 14929	IC NJM2177AFB3
IC306	4822 209 90023	IC NJU9701D
IC307	4822 209 91029	IC KIA4559P
IC308	4822 209 91026	IC TC9176
IC309	4822 209 91029	IC KIA4559P
Q301	4822 130 41947	Trans KTC3198Y
Q302	4822 130 41947	Trans KTC3198Y
Q303L	4822 130 63904	Trans KTD1302
Q303R	4822 130 63904	Trans KTD1302
Q304L	4822 130 63904	Trans KTD1302
Q304R	4822 130 63904	Trans KTD1302
Q306	4822 130 63907	Trans DTA114YS
Q307	4822 130 63904	Trans KTD1302
Q308	4822 130 63904	Trans KTD1302
Q309	4822 130 63907	Trans DTA114YS
Q310	4822 130 63907	Trans DTA114YS
Q311	4822 130 63906	Trans DTC114YS
Q312	4822 130 63906	Trans DTC114YS
Q313L	4822 130 41312	Trans KTC3200
Q313R	4822 130 41312	Trans KTC3200
Q314L	4822 130 41312	Trans KTC3200
Q314R	4822 130 41312	Trans KTC3200
Q315L	4822 130 42394	Trans KTC3198Y
Q315R	4822 130 42394	Trans KTC3198Y
Q316L	4822 130 42394	Trans KTC3198Y
Q316R	4822 130 42394	Trans KTC3198Y
Q317L	4822 130 63903	Trans KTA1024
Q317R	4822 130 63903	Trans KTA1024
Q318L	4822 130 63905	Trans KTC3206
Q318R	4822 130 63905	Trans KTC3206
Q319L	4822 130 63899	Trans 2SC4137

MAIN BOARD



Q319R	4822 130 63899	Trans 2SC4137
Q320L	4822 130 63898	Trans KSC2690A-Y
Q320R	4822 130 63898	Trans KSC2690A-Y
Q321L	4822 130 63897	Trans KSA1220A-Y
Q321R	4822 130 63897	Trans KSA1220A-Y
Q322L	4822 130 63895	Trans 2SC3854
Q322R	4822 130 63895	Trans 2SC3854
Q323L	4822 130 63894	Trans 2SA1490
Q323R	4822 130 63894	Trans 2SA1490
Q324L	4822 130 41947	Trans KTC3198Y
Q324R	4822 130 41947	Trans KTC3198Y
Q325	4822 130 41312	Trans KTC3200
Q326	4822 130 41312	Trans KTC3200
Q327	4822 130 42394	Trans KTC3198Y
Q328	4822 130 42394	Trans KTC3198Y
Q329	4822 130 63903	Trans KTA1024
Q330	4822 130 63905	Trans KTC3206
Q331	4822 130 63899	Trans 2SC4137
Q332	4822 130 63898	Trans KSC2690A-Y
Q333	4822 130 63897	Trans KSA1220A-Y
Q334	4822 130 63895	Trans 2SC3854
Q335	4822 130 63894	Trans 2SA1490
Q336	4822 130 41947	Trans KTC3198Y
Q337	4822 130 41312	Trans KTC3200
Q338	4822 130 41312	Trans KTC3200
Q339	4822 130 42394	Trans KTC3198Y
Q340	4822 130 42394	Trans KTC3198Y
Q341	4822 130 63903	Trans KTA1024
Q342	4822 130 63905	Trans KTC3206
Q343	4822 130 63899	Trans 2SC4137
Q344	4822 130 63898	Trans KSC2690A-Y
Q345	4822 130 63897	Trans KSA1220A-Y
Q346	4822 130 63895	Trans 2SC3854
Q347	4822 130 63894	Trans 2SA1490
Q348	4822 130 41947	Trans KTC3198Y
Q349	4822 130 41726	Trans KTA1015
Q350	4822 130 41947	Trans KTC3198Y
Q351	4822 130 41947	Trans KTC3198Y
Q504	4822 130 63907	Trans DTA114YS
Q505	4822 130 63906	Trans DTC114YS

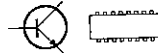

Q505L	4822 130 63904	Trans KTD1302
Q505R	4822 130 63904	Trans KTD1302

- MISCELLANEOUS -

JACK2	4822 265 10765	Terminal Speaker 6P
JACK5	4822 267 41251	Jack RCA 6P
JACK6	4822 267 41252	Jack RCA 6P

Note : Only those parts mentioned in the list are normal service parts.

TUNER BOARD

FR

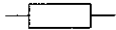

VR101	4822 117 12559	Semi-fixed Res 10K
VR102	4822 117 12561	Semi-fixed Res 100K
VR103	4822 117 12562	Semi-fixed Res 500K
VR104	4822 117 12563	Semi-fixed Res 2K
VR105	4822 117 12564	Semi-fixed Res 50K



TC101	4822 125 60228	Trimmer 20pF
TC102	4822 125 60227	Trimmer 10pF

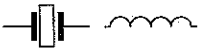

CF101	4822 242 82235	SFE10.7MS3GH-ATF21
CF102	4822 242 82235	SFE10.7MS3GH-ATF21
CF103	4822 157 11047	Filter CFM2-450BL
CF104	4822 242 82242	Filter BFU450C4N
FE101	4822 210 10676	FM Tuner FE407-G60
L101	4822 157 71881	AM-Ant Coil
L102	4822 157 71888	AM-Osc Coil
L103	4822 157 11048	FM-Det-A Coil ~
L104	4822 157 71895	FM-Det-B Coil
L105	4822 157 71893	Inductor 20.8mH
L106	4822 157 71896	AM IFT Coil
L107L	4822 157 11049	Filter MPX
L107R	4822 157 11049	Filter MPX
X101	4822 242 82238	Crystal 7.2MHz
X102	4822 242 10608	Crystal 4.332MHz
X103	4822 242 10607	Resonator 4.00MGW



D101	4822 130 30621	Diode 1N4148
D102	4822 130 30621	Diode 1N4148
D103	4822 130 30621	Diode 1N4148
D104	4822 130 30621	Diode 1N4148
D106	4822 130 70044	Zener UZ5.1BSB
D107	4822 130 70044	Zener UZ5.1BSB
D108	4822 130 30621	Diode 1N4148
D109	4822 130 30621	Diode 1N4148
D110	4822 130 70044	Zener UZ5.1BSB
D111	4822 130 30621	Diode 1N4148



D112	4822 130 30621	Diode 1N4148
VD101	4822 130 81197	VC Diode KV1236Z
VD102	4822 130 81197	VC Diode KV1236Z

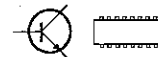

IC101	4822 209 91027	IC LA1266G
IC102	4822 209 91051	IC HA12016
IC103	4822 209 30152	IC LM7001
IC104	4822 209 91025	IC GD4066B
IC105	4822 209 73726	IC LA1235
IC106	4822 209 15022	IC LC7073
IC107	4822 209 33842	IC TDA7330B
Q101	4822 130 63896	Trans KTC3194Y
Q102	4822 130 41312	Trans KTC3200
Q103	4822 130 63908	FET 2SK168DTZ
Q104	4822 130 63907	Trans DTA114YS
Q105	4822 130 63907	Trans DTA114YS
Q106	4822 130 63907	Trans DTA114YS
Q107	4822 130 41947	Trans KTC3198Y
Q108	4822 130 63907	Trans DTA114YS
Q109L	4822 130 63904	Trans KTD1302
Q109R	4822 130 63904	Trans KTD1302
Q110	4822 130 41726	Trans KTA1266Y
Q111	4822 130 41947	Trans KTC3198Y
Q112	4822 130 41726	Trans KTA1266Y
Q113	4822 130 43546	FET 2SK117Y
Q114	4822 130 41947	Trans KTC3198Y

- MISCELLANEOUS -

J101	4822 265 10766	Jack RCA 2P
J102	4822 267 41253	Jack RCA 3P
J103	4822 267 31993	Jack Remote 2P
ANT101	4822 290 81738	Terminal Antenna

C20

X20

D20

D20

D20

D20

D20

D20

D20

D20

D20

D21

D21

D21

D21

D21

D21

D21

D21

D21

D21

D21

D22

D22

D22

IC20

IC20

Q20

Q20

Q20

Q20

Q20



Q20

Q20

Q20

Note : Only those parts mentioned in the list are normal service parts.

FRONT BOARD

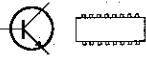
		
C204	4822 124 80923	Electrolytic Cap 0.047F
		
X200	4822 242 73769	CST4.19MGW-TF01
		
D200	4822 130 30621	Diode 1N4148
D201	4822 130 30621	Diode 1N4148
D202	4822 130 30621	Diode 1N4148
D203	4822 130 30621	Diode 1N4148
D204	4822 130 30621	Diode 1N4148
D205	4822 130 30621	Diode 1N4148
D207	4822 130 70048	Zener UZ27.0BSC
D208	4822 130 83742	Zener UZ6.2BSB
D209	4822 130 31878	Diode 1N4003
D210	4822 130 30621	LED SLR-54URCF03
D211	4822 130 30621	Diode 1N4148
D212	4822 130 30621	Diode 1N4148
D213	4822 130 30621	Diode 1N4148
D214	4822 130 30621	Diode 1N4148
D215	4822 130 70045	Zener UZ5.6BSB
D216	4822 130 70043	Zener UZ4.3BSB
D217	4822 130 30621	Diode 1N4148
D218	4822 130 30621	Diode 1N4148
D219	4822 130 70051	LED SLR-54URCF03
D220	4822 130 30621	Diode 1N4148
		
IC200	4822 209 15014	UPD78044AGF-210-3B9
IC201	4822 209 15015	IC MC14094
Q200	4822 130 41947	Trans KTC3198Y
Q201	4822 130 63906	Trans DTC114YS
Q202	4822 130 63906	Trans DTC114YS
Q203	4822 130 63906	Trans DTC114YS
Q204	4822 130 63906	Trans DTC114YS
Q205	4822 130 63906	Trans DTC114YS
Q206	4822 130 63906	Trans DTC114YS
Q207	4822 130 63906	Trans DTC114YS

		
Q208	4822 130 63907	Trans DTA114YS
Q209	4822 130 63907	Trans DTA114YS
Q210	4822 130 63907	Trans DTA114YS
Q211	4822 130 63906	Trans DTC114YS
Q212	4822 130 63907	Trans DTA114YS
Q213	4822 130 63906	Trans DTC114YS
Q214	4822 130 63906	Trans DTC114YS
- MISCELLANEOUS -		
FL201	4822 135 00076	FL Display CM1361C
RMC201	4822 130 91529	Remote Sen KRN-34LI
SW3	4822 276 13661	Tact Switch
SW4	4822 276 13661	Tact Switch
SW5	4822 276 13661	Tact Switch
SW6	4822 276 13661	Tact Switch
SW7	4822 276 13661	Tact Switch
SW8	4822 276 13661	Tact Switch
SW9	4822 276 13661	Tact Switch
SW10	4822 276 13661	Tact Switch
SW11	4822 276 13661	Tact Switch
SW12	4822 276 13661	Tact Switch
SW13	4822 276 13661	Tact Switch
SW14	4822 276 13661	Tact Switch
SW15	4822 276 13661	Tact Switch
SW16	4822 276 13661	Tact Switch
SW17	4822 276 13661	Tact Switch
SW18	4822 276 13661	Tact Switch
SW19	4822 276 13661	Tact Switch
SW20	4822 276 13661	Tact Switch
SW21	4822 276 13661	Tact Switch
SY200	4822 277 11645	Switch Encoder

Note : Only those parts mentioned in the list are normal service parts.

POWER BOARD



D601	4822 130 31878	Diode 1N4003
D602	4822 130 31878	Diode 1N4003
D603	4822 130 31878	Diode 1N4003
D604	4822 130 31878	Diode 1N4003
D605	4822 130 31878	Diode 1N4003
D606	4822 130 31878	Diode 1N4003
D607	4822 130 31878	Diode 1N4003
D608	4822 130 31878	Diode 1N4003
D609	4822 130 31878	Diode 1N4003
D610	4822 130 31878	Diode 1N4003
D611	4822 130 31878	Diode 1N4003



IC601	4822 209 91032	IC KA7915
IC602	4822 209 91033	IC KA7815
IC604	4822 209 91031	IC KA7806
Q601	4822 130 41947	Trans KTC3198Y

- MISCELLANEOUS -

F601	4822 253 50165	Fuse 5T 1A 250V
F602	4822 253 50165	Fuse 5T 1A 250V
F603	4822 253 50164	Fuse 5T 250MA 250V
F604	4822 253 50167	Fuse 5T 2.5A 250V
F605	4822 253 50166	Fuse 5T 2A 250V
J701	4822 265 31321	Jack RCA 3P
OUT601	4822 267 31994	AC Outlet 1P
RL601	4822 280 80794	Relay SDT-SS-112DM
SPKT901	4822 290 81736	Terminal Speaker 4P
SW1	4822 276 13807	Power Switch
SW2	4822 276 13658	Push Switch 2P2T
SW801	4822 267 31992	Jack Phone
	4822 146 31505	Standby Transf 230V
	4822 146 10662	Power Transf 230V

Note: Only those parts mentioned in the list are normal service parts.